



IKHTISAR DATA PENDIDIKAN DAN KEBUDAYAAN TAHUN 2014/15



**KEMENTERIAN PENDIDIKAN DAN KEBUDAYAAN
SEKRETARIAT JENDERAL
PUSAT DATA DAN STATISTIK PENDIDIKAN DAN KEBUDAYAAN
JAKARTA, 2015**

Kata Pengantar

Buku Saku Ikhtisar Data Pendidikan ini disusun oleh Pusat Data dan Statistik Pendidikan dan Kebudayaan (PDSPK), Kementerian Pendidikan dan Kebudayaan (Kemendikbud), untuk memenuhi berbagai permintaan data dan informasi pendidikan, khususnya bagi pimpinan dan pengambil keputusan di lingkungan Kemendikbud.

Data pendidikan disajikan secara ringkas sekolah, siswa baru, siswa, kepala sekolah dan guru, rombongan belajar, ruang kelas, lulusan, dan mengulang, dilengkapi dengan indikator pendidikan, angka melanjutkan (AM), angka partisipasi kasar (APK), angka partisipasi murni (APM).

Selain itu, disajikan pula perkembangan data dan indikator pendidikan. Agar mudah dipahami, data disajikan dalam bentuk tabel dan grafik. Waktu pencatatan data untuk jenjang TK, SLB, SD, SMP, SMA, dan SMK adalah 30 Juni 2015, dan untuk PAUD dan PNF adalah data pelaksanaan program tahun 2014.

Semoga buku ini bermanfaat, kritik dan saran untuk penyempurnaan sangat kami harapkan.

Sekretaris Jenderal



*Didik Suhardi, Ph.D
NIP.196312031983031004*

DAFTAR ISI

Kata Pengantar	Hal
Daftar Isi	ii
Data Pendidikan	
Tabel 1 : Data Pokok Pendidikan Menurut Jenjang Pendidikan Tahun 2014/15	2
Grafik 1 : Jumlah Sekolah Berdasarkan Jenjang Pendidikan dan Status Tahun 2014/15	2
Grafik 2 : Persentase Siswa menurut Jenis Kelamin dan Jenjang Pendidikan Tahun 2014/15	3
Grafik 3 : Persentase Guru menurut Jenis Kelamin dan Jenjang Pendidikan Tahun 2014/15	3
Tabel 2 : Data Pokok Pendidikan Taman Kanak-Kanak Tiap Provinsi Tahun 2014/15	4
Tabel 3 : Data Pokok Pendidikan Sekolah Luar Biasa Tiap Provinsi Tahun 2014/15	5
Tabel 4 : Data Pokok Pendidikan Sekolah Dasar Tiap Provinsi Tahun 2014/15	6
Tabel 4 : lanjutan Data Pokok Pendidikan Sekolah Dasar Tiap Provinsi Tahun 2014/15	7
Tabel 5 : Data Pokok Pendidikan Sekolah Menengah Pertama Tiap Provinsi Tahun 2014/15	8
Tabel 5 : lanjutan Data Pokok Pendidikan Sekolah Menengah Pertama Tiap Provinsi Tahun 2014/15	9
Tabel 6 : Data Pokok Pendidikan Sekolah Menengah Atas Tiap Provinsi Tahun 2014/15	10
Tabel 6 : lanjutan Data Pokok Pendidikan Sekolah Menengah Atas Tiap Provinsi Tahun 2014/15	11
Tabel 7 : Data Pokok Pendidikan Sekolah Menengah Kejuruan Tiap Provinsi Tahun 2014/15	12
Tabel 7 : lanjutan Data Pokok Pendidikan Sekolah Menengah Kejuruan Tiap Provinsi Tahun 2014/15	13
Tabel 8 : Jumlah Siswa Menurut Jenis Kelamin dan Status Tiap Provinsi Tahun 2014/15	14
Tabel 9 : Jumlah Siswa Menurut Tingkat, Jenjang Pendidikan dan Status Tahun 2014/15	15
Grafik 4 : Jumlah Siswa menurut Tingkat dan Status sekolah Tahun 2014/15	15
Tabel 10 : Jumlah Siswa Putus Sekolah Jenjang Sekolah Dasar Menurut Tingkat Tiap Provinsi Tahun 2014/15	17
Tabel 11 : Jumlah Siswa Putus Sekolah Jenjang Sekolah Menengah Pertama Menurut Tingkat Tiap Provinsi Tahun 2014/15	18
Tabel 12 : Jumlah Siswa Putus Sekolah Jenjang Sekolah Menengah Atas Menurut Tingkat Tiap Provinsi Tahun 2014/15	19
Tabel 13 : Jumlah Siswa Putus Sekolah Jenjang Sekolah Menengah Kejuruan Menurut Tingkat Tiap Provinsi Tahun 2014/15	20
Grafik 5 : Grafik Siswa Putus Sekolah Menurut Jenis Kelamin Tahun 2014/15	21
Grafik 6 : Grafik Mengulang Menurut Jenis Kelamin Tahun 2014/15	21
Tabel 14 : Jumlah Siswa Mengulang Jenjang Sekolah Dasar Menurut Tingkat Tiap Provinsi Tahun 2014/15	22
Tabel 15 : Jumlah Siswa Mengulang Jenjang Sekolah Menengah Pertama Menurut Tingkat Tiap Provinsi Tahun 2014/15	23
Tabel 16 : Jumlah Siswa Mengulang Jenjang Sekolah Menengah Atas Menurut Tingkat Tiap Provinsi Tahun 2014/15	24
Tabel 17 : Jumlah Siswa Mengulang Jenjang Sekolah Menengah Kejuruan Menurut Tingkat Tiap Provinsi Tahun 2014/15	25
Grafik 7 : Perkembangan Jumlah Siswa Putus Sekolah Menurut Jenjang Pendidikan Tahun 2014/15	26
Grafik 8 : Perkembangan Jumlah Siswa Mengulang Menurut Jenjang Pendidikan Tahun 2014/15	26

	Hal
Tabel 18 : Jumlah Kepala Sekolah + Guru Taman Kanak-kanak Menurut Ijazah Tertinggi Tiap Provinsi Tahun 2014/15	27
Tabel 19 : Jumlah Kepala Sekolah + Guru Sekolah Luar Biasa Menurut Ijazah Tertinggi Tiap Provinsi Tahun 2014/15	28
Tabel 20 : Jumlah Kepala Sekolah + Guru Sekolah Dasar Menurut Ijazah Tertinggi Tiap Provinsi Tahun 2014/15	29
Tabel 21 : Jumlah Kepala Sekolah + Guru Sekolah Menengah Pertama Menurut Ijazah Tertinggi Tiap Provinsi Tahun 2014/15	30
Tabel 22 : Jumlah Kepala Sekolah + Guru Sekolah Menengah Atas Menurut Ijazah Tertinggi Tiap Provinsi Tahun 2014/15	31
Tabel 23 : Jumlah Kepala Sekolah + Guru Sekolah Menengah Kejuruan Menurut Ijazah Tertinggi Tiap Provinsi Tahun 2014/15	32
Grafik 9 : Persentase Kepala Sekolah + Guru Menurut Ijazah Tertinggi Semua Jenjang Pendidikan Tahun 2014/15	33
Grafik 10 : Persentase Kepala Sekolah + Guru Menurut Jabatan Semua Jenjang Pendidikan Tahun 2014/15	33
Tabel 24 : Jumlah Kepala Sekolah + Guru Menurut Status dan Jenjang Pendidikan Tahun 2014/15	34
Tabel 25 : Jumlah Rombongan Belajar Sekolah Dasar Menurut Tingkat Tiap Provinsi Tahun 2014/15	35
Tabel 26 : Jumlah Rombongan Belajar Sekolah Menengah Pertama Menurut Tingkat Tiap Provinsi Tahun 2014/15	36
Tabel 27 : Jumlah Rombongan Belajar Sekolah Menengah Atas Menurut Tingkat Tiap Provinsi Tahun 2014/15	37
Tabel 28 : Jumlah Rombongan Belajar Sekolah Menengah Kejuruan Menurut Tingkat Tiap Provinsi Tahun 2014/15	38
Tabel 29 : Jumlah Ruang Kelas Menurut Kondisi dan Jenjang Pendidikan Semua Jenjang Pendidikan Tahun 2014/15	39
Grafik 10 : Persentase Ruang Kelas Menurut Kondisi Semua Jenjang Pendidikan Tahun 2014/15	39
Tabel 30 : Jumlah Ruang Kelas Sekolah Dasar Menurut Kondisi Tiap Provinsi Tahun 2014/15	40
Tabel 31 : Jumlah Ruang Kelas Sekolah Menengah Pertama Menurut Kondisi Tiap Provinsi Tahun 2014/15	41
Tabel 32 : Jumlah Ruang Kelas Sekolah Menengah Atas Menurut Kondisi Tiap Provinsi Tahun 2014/15	42
Tabel 33 : Jumlah Ruang Kelas Sekolah Menengah Kejuruan Menurut Kondisi Tiap Provinsi Tahun 2014/15	43
Tabel 34 : Angka Melanjutkan SD ke SMP Tiap Provinsi Tahun 2014/15	44
Tabel 35 : Angka Melanjutkan SMP ke SM Tiap Provinsi Tahun 2014/15	45
Tabel 36 : Angka Partisipasi Kasar PAUD, SD, SMP, SM Sederajat Tahun 2014/15	46
Grafik 11 : Angka Partisipasi Kasar PAUD, SD, SMP, SM Sederajat Tahun 2014/15	46
Tabel 37 : Angka Partisipasi Murni PAUD, SD, SMP, SM Sederajat Tahun 2014/15	47
Grafik 12 : Angka Partisipasi Murni PAUD, SD, SMP, SM Sederajat Tahun 2014/15	47
Tabel 38 : Angka Partisipasi Kasar dan Angka Partisipasi Murni Tiap Provinsi SD, SMP, SM Sederajat Tahun 2014/15	48

Data Kebudayaan

Tabel 1	: Data Pokok Kebudayaan Tahun 2014	Hal 50
Grafik 1	: Data Pokok Kebudayaan Tahun 2014	51
Tabel 2	: Jumlah Museum Menurut Penyelenggara Tahun 2014	52
Tabel 3	: Jumlah Jumlah Karya Budaya yang Sudah Ditetapkan Menurut Provinsi	53
Tabel 4	: Jumlah Jumlah Karya Budaya yang Sudah Ditetapkan Menurut Kategori Tahun 2014	53
Tabel 5	: Jumlah Jumlah Jumlah Cagar Budaya Berdasarkan Pemugaran Tahun 2014	54
Grafik 2	: Persentase Cagar Budaya Berdasarkan Pemugaran	55

DATA PENDIDIKAN 2014/2015

Tabel : 1
Data Pokok Pendidikan Menurut Jenjang Pendidikan
Tahun 2014/15

No.	Jenjang Pendidikan	Sekolah	Siswa Baru	Siswa	Guru	Rombongan Belajar	Ruang Kelas	Lulusan	Mengulang	Putus Sekolah
(1)	(2)	(3)	(4)	(5)	(6)	(7)	(8)	(9)	(10)	(11)
1.	TK	79.368	...	4.358.225	356.962		
	a. Negeri	2.764	...	281.653	15.516		
	b. Swasta	76.604	...	4.076.572	341.446		
2.	SLB	2.023	27.796	109.594	31.421	28.957	18.657	12.316		
	a. Negeri	532	10.203	42.440	11.816	7.990	5.195	3.368		
	b. Swasta	1.491	17.593	67.154	19.605	20.967	13.462	8.948		
3.	SD	147.513	4.431.362	26.132.141	1.842.862	1.096.930	1.054.331	4.369.259	375.142	176.909
	a. Negeri	132.609	3.864.345	23.138.933	1.636.818	971.182	929.012	3.963.909	346.440	153.917
	b. Swasta	14.904	567.017	2.993.208	206.044	125.748	125.319	405.350	28.702	22.992
4.	SMP	36.518	3.376.033	9.930.647	795.960	338.035	337.360	3.075.589	22.931	85.000
	a. Negeri	22.209	2.516.436	7.402.381	549.981	248.752	247.711	2.331.259	17.889	58.022
	b. Swasta	14.309	859.597	2.528.266	245.979	89.283	89.649	744.330	5.042	26.978
5.	SMA	12.513	1.438.298	4.232.572	362.693	140.568	146.207	1.429.795	27.048	68.219
	a. Negeri	6.232	1.068.490	3.140.513	231.135	98.144	101.710	961.844	17.003	45.307
	b. Swasta	6.281	369.808	1.092.059	131.558	42.424	44.497	467.951	10.045	22.912
6.	SMK	12.421	1.440.972	4.211.245	359.099	143.961	134.476	1.343.102	35.767	86.282
	a. Negeri	3.250	828.273	1.748.338	141.581	59.356	54.571	508.636	10.334	31.131
	b. Swasta	9.171	612.699	2.462.907	217.518	84.605	79.905	834.466	25.433	55.151
	Jumlah Total	290.356	10.714.461	48.974.424	3.748.997	1.748.451	1.691.031	10.230.061	460.888	416.410
	a. Negeri	167.596	8.287.747	35.754.258	2.586.847	1.385.424	1.338.199	7.769.016	391.666	288.377
	b. Swasta	122.760	2.426.714	13.220.166	1.162.150	363.027	352.832	2.461.045	69.222	128.033

Grafik : 1
Jumlah Sekolah Berdasarkan Jenjang Pendidikan dan Status
Tahun 2014/15

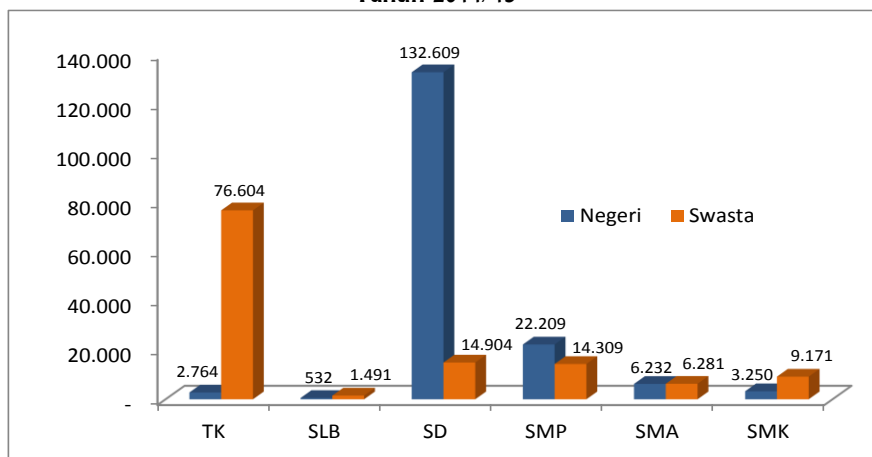

Grafik : 2
Persentase Siswa menurut Jenis Kelamin dan Jenjang Pendidikan
Tahun 2014/15

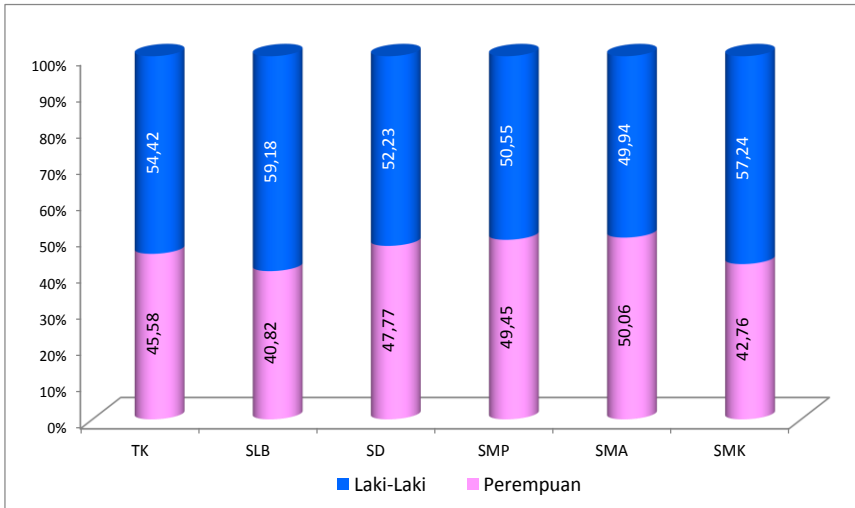

Grafik : 3
Persentase Guru menurut Jenis Kelamin dan Jenjang Pendidikan
Tahun 2014/15

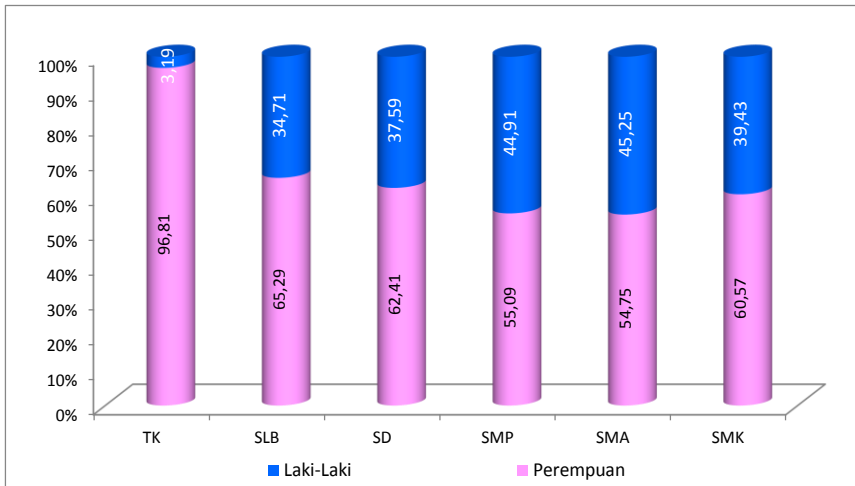

Tabel : 2
Data Pokok Pendidikan Taman Kanak-Kanak Tiap Provinsi
Tahun 2014/15

No.	Provinsi	Sekolah	S i s w a	Guru
(1)	(2)	(3)	(4)	(5)
1	DKI Jakarta	1.477	126.538	7.839
2	Jawa Barat	7.420	403.107	35.597
3	Banten	1.784	170.092	8.054
4	Jawa Tengah	13.564	689.884	58.081
5	DI Yogyakarta	2.121	96.927	8.592
6	Jawa Timur	16.724	927.849	76.453
7	Aceh	1.983	99.314	10.657
8	Sumatera Utara	2.254	183.989	8.797
9	Sumatera Barat	2.068	84.712	8.757
10	R i a u	1.759	100.838	6.057
11	Kep. Riau	496	44.344	2.588
12	J a m b i	1.005	39.787	4.647
13	Sumatera Selatan	1.589	74.811	7.823
14	Bangka Belitung	346	29.794	2.127
15	Bengkulu	894	35.472	3.857
16	Lampung	2.603	115.725	13.076
17	Kalimantan Barat	699	52.549	3.558
18	Kalimantan Tengah	1.471	57.891	6.602
19	Kalimantan Selatan	2.385	96.457	11.553
20	Kalimantan Timur	1.337	50.605	7.432
21	Kalimantan Utara	176	12.640	1.050
22	Sulawesi Utara	1.509	65.254	3.532
23	Gorontalo	761	28.726	2.546
24	Sulawesi Tengah	1.377	81.418	5.954
25	Sulawesi Selatan	3.853	210.998	17.728
26	Sulawesi Barat	591	20.678	2.407
27	Sulawesi Tenggara	1.476	90.741	6.749
28	M a l u k u	322	20.914	1.078
29	Maluku Utara	373	21.467	1.442
30	B a l i	1.448	82.195	7.168
31	Nusa Tenggara Barat	1.523	112.002	8.706
32	Nusa Tenggara Timur	1.256	80.582	3.728
33	Papua	457	37.024	1.647
34	Papua Barat	267	12.901	1.080
	Indonesia	79.368	4.358.225	356.962

Tabel : 3
Data Pokok Pendidikan Sekolah Luar Biasa Tiap Provinsi
Tahun 2014/15

No.	Provinsi	Sekolah	Siswa Baru	S i s w a	Lulusan	Guru	Rombongan Belajar	Ruang Kelas
(1)	(2)	(3)	(4)	(5)	(6)	(7)	(8)	(9)
1	DKI Jakarta	86	1.194	5.242	730	1.370	1.356	924
2	Jawa Barat	350	4.644	19.051	2.511	5.444	5.829	3.452
3	Banten	74	909	4.194	510	1.176	915	711
4	Jawa Tengah	180	3.486	13.610	1.367	3.501	2.496	1.355
5	DI Yogyakarta	75	1.192	4.899	648	1.622	1.740	996
6	Jawa Timur	430	4.391	16.220	2.046	4.864	5.047	2.885
7	Aceh	56	594	2.309	251	931	492	265
8	Sumatera Utara	43	1.215	3.779	331	734	576	350
9	Sumatera Barat	131	1.498	5.536	684	1.644	1.720	1.390
10	R i a u	37	613	1.959	175	617	568	445
11	Kep. Riau	13	195	994	98	232	141	83
12	J a m b i	15	359	1.509	95	367	206	137
13	Sumatera Selatan	29	547	2.018	202	537	401	240
14	Bangka Belitung	12	193	753	61	234	295	188
15	Bengkulu	16	295	1.087	110	312	282	177
16	Lampung	23	396	1.503	162	438	348	200
17	Kalimantan Barat	21	264	1.127	132	262	325	249
18	Kalimantan Tengah	19	184	816	69	265	224	147
19	Kalimantan Selatan	42	431	1.886	188	735	769	546
20	Kalimantan Timur	32	506	1.845	202	445	435	277
21	Kalimantan Utara	4	5	12	2	57	4	15
22	Sulawesi Utara	19	271	825	107	258	163	130
23	Gorontalo	11	207	999	81	224	205	105
24	Sulawesi Tengah	18	245	1.090	97	314	237	153
25	Sulawesi Selatan	81	1.144	4.390	332	1.384	1.198	1.098
26	Sulawesi Barat	20	195	874	89	323	237	196
27	Sulawesi Tenggara	52	432	2.283	217	649	612	540
28	M a l u k u	11	215	629	59	154	178	105
29	Maluku Utara	17	192	765	69	232	227	135
30	B a l i	16	388	1.735	151	432	307	190
31	Nusa Tenggara Barat	38	752	2.708	261	819	751	529
32	Nusa Tenggara Timur	38	531	2.374	221	749	495	327
33	Papua	8	75	403	41	61	127	80
34	Papua Barat	6	38	170	17	35	51	37
Indonesia		2.023	27.796	109.594	12.316	31.421	28.957	18.657

Tabel : 4
Data Pokok Pendidikan Sekolah Dasar Tiap Provinsi
Tahun 2014/15

No.	Provinsi	Sekolah	Siswa Baru	S i s w a	Lulusan	Guru
(1)	(2)	(3)	(4)	(5)	(6)	(7)
1	DKI Jakarta	2.770	131.755	838.426	134.142	44.055
2	Jawa Barat	19.817	749.164	4.611.703	767.720	247.693
3	Banten	4.523	205.967	1.211.609	209.614	64.334
4	Jawa Tengah	19.144	487.795	2.941.627	528.158	227.036
5	DI Yogyakarta	1.848	49.482	289.832	49.078	24.687
6	Jawa Timur	19.428	486.255	2.963.790	525.074	242.844
7	Aceh	3.392	85.559	484.913	86.595	52.831
8	Sumatera Utara	9.490	308.325	1.790.466	295.637	121.809
9	Sumatera Barat	4.115	112.189	657.150	109.491	50.796
10	R i a u	3.568	142.875	794.825	122.518	54.566
11	Kep. Riau	880	39.538	214.003	26.647	13.626
12	J a m b i	2.414	69.388	398.456	67.381	30.356
13	Sumatera Selatan	4.609	168.675	941.957	150.817	65.280
14	Bangka Belitung	789	28.426	158.230	23.022	9.791
15	Bengkulu	1.351	37.698	221.130	37.990	17.361
16	Lampung	4.606	147.979	846.315	161.544	61.925
17	Kalimantan Barat	4.308	112.413	616.996	99.370	44.952
18	Kalimantan Tengah	2.590	52.259	295.945	52.331	27.734
19	Kalimantan Selatan	2.899	68.538	386.557	64.306	33.946
20	Kalimantan Timur	1.826	72.698	409.120	57.452	27.208
21	Kalimantan Utara	451	14.320	77.694	10.979	6.092
22	Sulawesi Utara	2.214	42.200	269.015	43.726	21.620
23	Gorontalo	928	23.506	138.523	24.537	9.780
24	Sulawesi Tengah	2.835	63.183	375.072	56.136	30.860
25	Sulawesi Selatan	6.348	161.782	997.473	165.682	79.878
26	Sulawesi Barat	1.306	28.918	173.941	28.433	14.404
27	Sulawesi Tenggara	2.268	55.798	342.647	55.337	26.723
28	M a l u k u	1.731	41.129	235.170	44.056	19.499
29	Maluku Utara	1.272	28.644	166.128	21.460	12.043
30	B a l i	2.434	68.249	410.396	65.869	29.118
31	Nusa Tenggara Barat	3.139	87.799	518.881	89.685	43.729
32	Nusa Tenggara Timur	4.921	151.930	831.899	126.469	58.844
33	Papua	2.323	81.303	391.123	49.347	19.212
34	Papua Barat	976	25.623	131.129	18.776	8.230
	Indonesia	147.513	4.431.362	26.132.141	4.369.379	1.842.862

Tabel : 4 lanjutan
Data Pokok Pendidikan Sekolah Dasar Tiap Provinsi
Tahun 2014/15

No.	Provinsi	Mengulang		Putus Sekolah		Rombongan Belajar	Ruang Kelas
		Jumlah	%	Jumlah	%		
(1)	(2)	(3)	(4)	(5)	(6)	(7)	(8)
1	DKI Jakarta	11.271	1,37	6.216	0,76	27.838	25.455
2	Jawa Barat	32.677	0,69	34.940	0,74	159.533	139.525
3	Banten	15.572	1,31	7.911	0,66	40.815	35.184
4	Jawa Tengah	49.984	1,56	9.419	0,29	127.122	128.091
5	DI Yogyakarta	3.717	1,27	997	0,34	13.497	14.018
6	Jawa Timur	33.396	1,08	10.587	0,34	135.185	135.066
7	Aceh	7.824	1,57	4.200	0,84	23.629	24.103
8	Sumatera Utara	15.488	0,88	13.499	0,76	72.399	70.464
9	Sumatera Barat	19.143	2,90	4.062	0,62	29.960	30.122
10	Riau	8.093	1,14	6.487	0,91	32.666	30.443
11	Kep. Riau	3.421	1,98	1.509	0,87	8.585	7.206
12	Jambi	6.921	1,73	4.251	1,06	18.197	17.847
13	Sumatera Selatan	11.516	1,27	7.527	0,83	38.665	34.736
14	Bangka Belitung	5.763	3,90	915	0,62	6.378	6.501
15	Bengkulu	4.464	1,94	1.678	0,73	10.435	10.318
16	Lampung	10.015	1,03	5.452	0,56	36.369	33.901
17	Kalimantan Barat	19.808	3,21	4.444	0,72	30.456	28.758
18	Kalimantan Tengah	5.911	1,94	3.268	1,07	17.047	16.854
19	Kalimantan Selatan	9.058	2,31	2.819	0,72	20.258	20.554
20	Kalimantan Timur	8.310	2,29	3.459	0,97	17.011	15.491
21	Kalimantan Utara	1.649	2,48	610	0,83	3.679	3.635
22	Sulawesi Utara	3.032	1,10	2.332	0,85	14.339	14.760
23	Gorontalo	4.922	3,11	1.109	0,70	6.240	6.415
24	Sulawesi Tengah	8.567	2,42	3.403	0,96	18.657	19.065
25	Sulawesi Selatan	15.565	1,52	9.057	0,88	45.388	44.103
26	Sulawesi Barat	3.278	1,87	1.706	0,97	8.789	8.608
27	Sulawesi Tenggara	6.522	1,92	4.025	1,18	16.326	15.655
28	Maluku	1.445	0,54	2.256	0,85	11.539	11.696
29	Maluku Utara	1.904	1,07	1.951	1,09	8.029	8.120
30	Bali	3.746	0,92	1.426	0,35	16.837	16.436
31	Nusa Tenggara Barat	7.405	1,39	2.890	0,54	21.912	20.931
32	Nusa Tenggara Timur	24.475	3,10	5.491	0,69	36.855	38.772
33	Papua	6.891	2,05	4.913	1,46	15.637	15.319
34	Papua Barat	3.389	2,88	2.100	1,79	6.658	6.179
	Indonesia	375.142	1,42	176.909	0,67	1.096.930	1.054.331

Tabel : 5
Data Pokok Pendidikan Sekolah Menengah Pertama Tiap Provinsi
Tahun 2014/15

No.	Provinsi	Sekolah	Siswa Baru	S i s w a	Lulusan	Guru
(1)	(2)	(3)	(4)	(5)	(6)	(7)
1	DKI Jakarta	1.066	125.956	379.008	127.428	24.965
2	Jawa Barat	4.616	600.547	1.771.321	528.310	110.479
3	Banten	1.317	144.214	426.848	133.607	27.554
4	Jawa Tengah	3.200	408.246	1.219.304	390.887	86.058
5	DI Yogyakarta	434	43.385	129.809	45.818	11.502
6	Jawa Timur	4.376	424.290	1.259.024	389.556	103.521
7	Aceh	1.021	66.380	201.489	68.145	25.376
8	Sumatera Utara	2.392	220.994	649.018	212.574	54.317
9	Sumatera Barat	762	72.778	210.687	71.764	21.440
10	R i a u	1.061	84.438	242.407	76.424	21.317
11	Kep. Riau	296	26.607	74.457	22.474	5.280
12	J a m b i	628	41.101	121.401	38.586	12.177
13	Sumatera Selatan	1.239	117.783	341.351	102.023	29.651
14	Bangka Belitung	196	18.999	54.080	17.143	3.492
15	Bengkulu	413	28.961	86.453	25.740	8.148
16	Lampung	1.274	106.643	318.545	94.676	29.025
17	Kalimantan Barat	1.206	77.504	215.866	59.729	17.471
18	Kalimantan Tengah	766	35.657	100.266	26.313	10.481
19	Kalimantan Selatan	576	40.246	117.116	36.031	10.890
20	Kalimantan Timur	583	51.590	147.326	44.629	10.933
21	Kalimantan Utara	152	10.318	28.590	7.829	2.456
22	Sulawesi Utara	691	40.085	116.680	35.000	11.240
23	Gorontalo	318	16.449	48.334	14.544	4.757
24	Sulawesi Tengah	788	42.365	124.396	35.524	12.267
25	Sulawesi Selatan	1.585	130.920	389.984	128.434	36.458
26	Sulawesi Barat	320	20.439	58.733	17.636	5.419
27	Sulawesi Tenggara	685	41.245	122.220	38.403	12.316
28	M a l u k u	591	31.592	94.389	28.197	9.222
29	Maluku Utara	437	19.689	57.319	17.753	5.878
30	B a l i	395	65.308	193.916	60.090	13.909
31	Nusa Tenggara Barat	826	60.190	178.236	56.759	20.449
32	Nusa Tenggara Timur	1.472	107.931	301.796	84.218	25.368
33	Papua	578	38.401	108.512	26.294	8.410
34	Papua Barat	258	14.782	41.766	13.051	3.734
	Indonesia	36.518	3.376.033	9.930.647	3.075.589	795.960

Tabel : 5 lanjutan
Data Pokok Pendidikan Sekolah Menengah Pertama Tiap Provinsi
Tahun 2014/15

No.	Provinsi	Mengulang		Putus Sekolah		Rombongan Belajar	Ruang Kelas
		Jumlah	%	Jumlah	%		
(1)	(2)	(3)	(4)	(5)	(6)	(7)	(8)
1	DKI Jakarta	939	0,26	2.716	0,74	12.099	10.655
2	Jawa Barat	1.037	0,06	19.314	1,11	52.826	51.419
3	Banten	746	0,18	3.885	0,93	12.854	12.806
4	Jawa Tengah	1.683	0,14	6.194	0,51	40.370	39.545
5	DI Yogyakarta	258	0,20	362	0,28	4.575	4.696
6	Jawa Timur	1.595	0,13	8.564	0,69	43.607	42.962
7	Aceh	922	0,46	2.465	1,23	8.010	8.888
8	Sumatera Utara	1.417	0,22	4.709	0,73	21.004	21.345
9	Sumatera Barat	961	0,46	1.482	0,71	7.914	8.152
10	R i a u	1.057	0,46	1.766	0,76	8.664	8.947
11	Kep. Riau	331	0,50	546	0,82	2.492	2.511
12	J a m b i	669	0,56	1.304	1,08	4.639	4.927
13	Sumatera Selatan	1.226	0,37	2.415	0,72	10.901	10.806
14	Bangka Belitung	328	0,61	405	0,76	1.784	1.934
15	Bengkulu	508	0,61	644	0,77	3.343	3.423
16	Lampung	827	0,26	2.825	0,89	10.937	10.907
17	Kalimantan Barat	922	0,46	1.976	0,98	7.646	8.025
18	Kalimantan Tengah	260	0,27	1.354	1,42	4.170	4.389
19	Kalimantan Selatan	482	0,44	821	0,75	4.523	4.590
20	Kalimantan Timur	265	0,19	1.241	0,90	5.116	5.066
21	Kalimantan Utara	100	0,37	407	1,51	1.051	1.007
22	Sulawesi Utara	338	0,30	1.103	0,98	4.692	4.816
23	Gorontalo	300	0,64	398	0,85	2.022	2.077
24	Sulawesi Tengah	656	0,54	1.165	0,97	5.265	5.599
25	Sulawesi Selatan	912	0,24	4.637	1,21	14.474	14.373
26	Sulawesi Barat	187	0,33	896	1,56	2.241	2.386
27	Sulawesi Tenggara	697	0,58	1.594	1,32	5.123	5.373
28	M a l u k u	511	0,57	920	1,03	3.887	3.995
29	Maluku Utara	299	0,53	714	1,26	2.368	2.452
30	B a l i	161	0,09	984	0,52	6.066	5.047
31	Nusa Tenggara Barat	573	0,32	1.467	0,83	6.808	6.671
32	Nusa Tenggara Timur	800	0,28	3.490	1,23	11.169	11.913
33	Papua	710	0,75	1.593	1,68	3.758	3.913
34	Papua Barat	254	0,64	644	1,63	1.637	1.745
	Indonesia	22.931	0,24	85.000	0,87	338.035	337.360

Tabel : 6
Data Pokok Pendidikan Sekolah Menengah Atas Tiap Provinsi
Tahun 2014/15

No.	Provinsi	Sekolah	Siswa Baru	S i s w a	Lulusan	Guru
(1)	(2)	(3)	(4)	(5)	(6)	(7)
1	DKI Jakarta	470	48.575	153.900	68.679	13.514
2	Jawa Barat	1.415	189.652	551.853	187.154	42.000
3	Banten	488	54.086	155.829	48.282	12.423
4	Jawa Tengah	855	123.150	364.216	132.810	29.404
5	DI Yogyakarta	162	16.817	50.954	17.163	5.251
6	Jawa Timur	1.426	164.205	482.309	159.564	41.791
7	Aceh	481	44.312	136.543	56.584	15.166
8	Sumatera Utara	1.007	115.833	332.243	115.106	28.062
9	Sumatera Barat	296	44.938	136.468	46.299	12.742
10	R i a u	400	45.093	134.974	38.156	11.483
11	Kep. Riau	109	11.528	33.710	11.263	2.587
12	J a m b i	209	23.606	68.521	24.607	5.999
13	Sumatera Selatan	570	64.604	190.991	69.107	17.939
14	Bangka Belitung	66	7.567	21.036	7.505	1.707
15	Bengkulu	129	14.718	44.341	15.736	4.189
16	Lampung	456	45.331	134.904	41.933	13.307
17	Kalimantan Barat	366	35.045	103.322	29.556	7.902
18	Kalimantan Tengah	225	16.542	47.731	17.177	4.732
19	Kalimantan Selatan	185	19.148	54.470	17.774	4.901
20	Kalimantan Timur	207	20.840	60.295	24.492	4.944
21	Kalimantan Utara	54	4.606	13.871	8.423	1.215
22	Sulawesi Utara	208	17.451	50.771	16.957	4.571
23	Gorontalo	53	8.020	23.645	7.965	1.590
24	Sulawesi Tengah	187	20.895	61.135	18.477	4.656
25	Sulawesi Selatan	550	72.565	214.143	58.697	17.404
26	Sulawesi Barat	71	8.547	24.290	7.451	1.804
27	Sulawesi Tenggara	265	27.577	80.497	30.941	7.131
28	M a l u k u	245	21.310	63.452	20.227	5.796
29	Maluku Utara	169	11.226	33.868	10.498	3.301
30	B a l i	164	27.128	79.145	25.298	6.785
31	Nusa Tenggara Barat	293	34.983	100.642	34.530	10.229
32	Nusa Tenggara Timur	435	53.737	155.086	38.745	11.967
33	Papua	192	16.721	50.641	14.649	4.139
34	Papua Barat	105	7.942	22.776	7.990	2.062
	Indonesia	12.513	1.438.298	4.232.572	1.429.795	362.693

Tabel : 6 lanjutan
Data Pokok Pendidikan Sekolah Menengah Atas Tiap Provinsi
Tahun 2014/15

No.	Provinsi	Mengulang		Putus Sekolah		Rombongan Belajar	Ruang Kelas
		Jumlah	%	Jumlah	%		
(1)	(2)	(3)	(4)	(5)	(6)	(7)	(8)
1	DKI Jakarta	1.540	0,84	1.250	0,68	5.219	5.266
2	Jawa Barat	1.451	0,26	8.171	1,44	16.914	17.788
3	Banten	537	0,34	2.515	1,60	4.921	5.357
4	Jawa Tengah	1.699	0,42	4.081	1,02	12.032	12.856
5	DI Yogyakarta	461	0,87	317	0,60	2.009	2.040
6	Jawa Timur	1.487	0,30	6.166	1,25	16.041	16.556
7	Aceh	1.059	0,69	2.777	1,80	5.071	5.443
8	Sumatera Utara	1.226	0,36	5.739	1,66	9.947	10.305
9	Sumatera Barat	1.275	0,97	2.543	1,93	4.608	4.765
10	R i a u	995	0,83	1.978	1,66	4.468	4.749
11	Kep. Riau	311	0,90	411	1,19	1.158	1.231
12	J a m b i	506	0,75	798	1,18	2.327	2.378
13	Sumatera Selatan	892	0,44	3.613	1,79	5.937	6.200
14	Bangka Belitung	303	1,41	366	1,71	739	786
15	Bengkulu	293	0,61	767	1,59	1.515	1.610
16	Lampung	742	0,59	2.142	1,70	4.519	4.759
17	Kalimantan Barat	1.708	1,74	2.190	2,23	3.322	3.457
18	Kalimantan Tengah	308	0,65	1.239	2,61	1.861	2.039
19	Kalimantan Selatan	556	1,00	898	1,62	1.950	2.105
20	Kalimantan Timur	495	0,67	1.105	1,78	2.098	2.227
21	Kalimantan Utara	309	2,72	167	1,47	498	466
22	Sulawesi Utara	381	0,73	917	1,76	2.084	2.108
23	Gorontalo	285	1,45	744	3,79	799	868
24	Sulawesi Tengah	1.042	1,79	1.449	2,50	2.089	2.100
25	Sulawesi Selatan	1.206	0,60	3.595	1,80	6.939	7.197
26	Sulawesi Barat	329	1,44	425	1,86	809	844
27	Sulawesi Tenggara	617	0,80	2.196	2,84	2.959	2.950
28	M a l u k u	472	0,76	927	1,48	2.428	2.403
29	Maluku Utara	408	1,20	695	2,04	1.306	1.324
30	B a l i	280	0,33	810	0,97	2.579	2.480
31	Nusa Tenggara Barat	761	0,77	2.453	2,47	3.193	3.341
32	Nusa Tenggara Timur	1.350	1,05	3.198	2,49	5.482	5.490
33	Papua	1.303	2,66	873	1,78	1.829	1.809
34	Papua Barat	461	1,97	704	3,01	918	910
	Indonesia	27.048	0,63	27048	1,59	140.568	146.207

Tabel : 7
Data Pokok Pendidikan Sekolah Menengah Kejuruan Tiap Provinsi
Tahun 2014/15

No.	Provinsi	Sekolah	Siswa Baru	S i s w a	Lulusan	Guru
(1)	(2)	(3)	(4)	(5)	(6)	(7)
1	DKI Jakarta	600	66.912	201.811	75.605	15.951
2	Jawa Barat	2.442	298.242	858.742	238.184	64.610
3	Banten	607	71.810	210.175	58.237	15.801
4	Jawa Tengah	1.490	236.459	687.148	190.745	49.858
5	DI Yogyakarta	222	26.586	81.712	25.456	8.136
6	Jawa Timur	1.759	219.101	656.383	230.759	53.463
7	Aceh	184	15.376	43.214	15.764	6.199
8	Sumatera Utara	931	94.820	276.980	112.709	25.117
9	Sumatera Barat	191	25.620	73.577	27.640	8.287
10	R i a u	253	26.316	77.971	25.561	7.220
11	Kep. Riau	86	7.935	23.381	7.100	2.105
12	J a m b i	154	14.318	41.403	13.427	4.213
13	Sumatera Selatan	256	32.899	90.410	29.540	8.395
14	Bangka Belitung	52	7.250	20.896	6.628	1.725
15	Bengkulu	86	8.052	24.029	7.202	2.767
16	Lampung	400	39.703	114.038	31.550	11.507
17	Kalimantan Barat	175	16.959	48.756	17.145	4.197
18	Kalimantan Tengah	125	9.460	25.819	7.807	2.834
19	Kalimantan Selatan	115	16.148	47.867	12.779	3.843
20	Kalimantan Timur	208	22.628	66.829	19.663	5.744
21	Kalimantan Utara	24	2.688	7.669	2.361	759
22	Sulawesi Utara	167	15.378	45.587	18.475	3.919
23	Gorontalo	50	6.256	17.979	6.536	1.578
24	Sulawesi Tengah	163	11.697	35.306	12.504	3.738
25	Sulawesi Selatan	415	40.557	123.119	44.889	12.611
26	Sulawesi Barat	113	8.655	24.962	7.839	2.209
27	Sulawesi Tenggara	138	9.461	26.989	8.979	3.420
28	M a l u k u	101	5.862	16.404	5.821	2.357
29	Maluku Utara	103	4.821	14.850	4.820	1.855
30	B a l i	168	27.054	80.722	25.435	6.780
31	Nusa Tenggara Barat	260	20.782	58.759	13.651	7.897
32	Nusa Tenggara Timur	229	19.506	54.532	24.724	6.178
33	Papua	110	8.401	22.638	9.258	2.699
34	Papua Barat	44	3.260	10.588	4.309	1.127
	Indonesia	12.421	1.440.972	4.211.245	1.343.102	359.099

Tabel : 7 lanjutan
Data Pokok Pendidikan Sekolah Menengah Kejuruan Tiap Provinsi
Tahun 2014/15

No.	Provinsi	Mengulang		Putus Sekolah		Rombongan Belajar	Ruang Kelas
		Jumlah	%	Jumlah	%		
(1)	(2)	(3)	(4)	(5)	(6)	(7)	(8)
1	DKI Jakarta	1.055	0,45	2.651	1,12	6.684	6.073
2	Jawa Barat	6.876	0,92	15.731	2,10	27.198	25.207
3	Banten	1.857	0,99	4.272	2,28	6.657	6.397
4	Jawa Tengah	5.300	0,86	12.082	1,95	21.888	19.997
5	DI Yogyakarta	330	0,39	936	1,10	3.087	2.948
6	Jawa Timur	5.127	0,73	12.070	1,73	21.166	18.388
7	Aceh	312	0,63	851	1,73	1.943	1.993
8	Sumatera Utara	3.767	1,10	8.899	2,61	9.368	9.177
9	Sumatera Barat	451	0,52	1.869	2,17	2.799	2.510
10	R i a u	628	0,79	1.522	1,92	2.975	3.099
11	Kep. Riau	107	0,49	350	1,59	973	932
12	J a m b i	308	0,75	781	1,91	1.595	1.606
13	Sumatera Selatan	810	0,89	2.162	2,37	2.982	2.817
14	Bangka Belitung	176	0,86	513	2,50	698	786
15	Bengkulu	206	0,81	588	2,30	1.001	1.043
16	Lampung	1.119	1,03	2.711	2,50	3.893	3.734
17	Kalimantan Barat	516	1,00	1.419	2,75	1.685	1.742
18	Kalimantan Tengah	247	1,04	693	2,93	1.086	1.164
19	Kalimantan Selatan	518	1,27	1.243	3,04	1.608	1.482
20	Kalimantan Timur	692	1,12	1.628	2,63	2.500	2.338
21	Kalimantan Utara	16	0,21	32	0,42	270	272
22	Sulawesi Utara	431	0,79	1.035	1,90	2.021	1.947
23	Gorontalo	158	0,84	573	3,03	714	785
24	Sulawesi Tengah	473	1,31	1.071	2,96	1.597	1.564
25	Sulawesi Selatan	1.083	0,80	2.912	2,16	4.861	4.636
26	Sulawesi Barat	331	1,33	660	2,64	937	966
27	Sulawesi Tenggara	495	1,81	1.365	4,99	1.289	1.344
28	M a l u k u	114	0,62	302	1,63	866	801
29	Maluku Utara	206	1,31	403	2,56	737	697
30	B a l i	416	0,52	912	1,14	2.622	2.097
31	Nusa Tenggara Barat	747	1,54	1.730	3,58	2.287	2.118
32	Nusa Tenggara Timur	586	0,79	1.608	2,17	2.354	2.237
33	Papua	156	0,55	387	1,38	1.154	1.100
34	Papua Barat	153	1,08	321	2,27	466	479
	Indonesia	35.767	0,85	86.282	2,05	143.961	134.476

Tabel : 8
Jumlah Siswa Menurut Jenis Kelamin dan Status Tiap Provinsi
Tahun 2014/15

No.	Provinsi	SD		SMP		SMA		SMK	
		Laki-laki	Perempuan	Laki-laki	Perempuan	Laki-laki	Perempuan	Laki-laki	Perempuan
(1)	(2)	(3)	(4)	(5)	(6)	(7)	(8)	(9)	(10)
1	DKI Jakarta	435.772	402.654	190.261	188.747	77.600	76.300	102.276	99.535
2	Jawa Barat	2.387.274	2.224.429	893.037	878.284	274.189	277.664	496.844	361.898
3	Banten	630.437	581.172	218.767	208.081	78.181	77.648	118.591	91.584
4	Jawa Tengah	1.539.307	1.402.320	613.485	605.819	174.280	189.936	398.571	288.577
5	DI Yogyakarta	151.659	138.173	65.821	63.988	25.835	25.119	45.824	35.888
6	Jawa Timur	1.547.733	1.416.057	650.031	608.993	239.476	242.833	391.463	264.920
7	Aceh	255.468	229.445	103.517	97.972	63.916	72.627	25.683	17.531
8	Sumatera Utara	934.974	855.492	329.768	319.250	162.727	169.516	152.999	123.981
9	Sumatera Barat	345.164	311.986	104.652	106.035	71.297	65.171	42.552	31.025
10	Riau	416.092	378.733	121.654	120.753	65.399	69.575	45.802	32.169
11	Kep. Riau	111.607	102.396	37.774	36.683	16.139	17.571	13.634	9.747
12	Jambi	208.420	190.036	60.953	60.448	33.264	35.257	23.568	17.835
13	Sumatera Selatan	491.620	450.337	171.044	170.307	96.270	94.721	52.975	37.435
14	Bangka Belitung	83.117	75.113	26.692	27.388	10.657	10.379	11.052	9.844
15	Bengkulu	116.294	104.836	43.666	42.787	25.268	19.073	14.332	9.697
16	Lampung	441.571	404.744	158.648	159.897	66.460	68.444	64.880	49.158
17	Kalimantan Barat	323.568	293.428	104.680	111.186	50.535	52.787	26.230	22.526
18	Kalimantan Tengah	155.262	140.683	50.084	50.182	23.558	24.173	14.880	10.939
19	Kalimantan Selatan	202.624	183.933	59.969	57.147	26.583	27.887	28.347	19.520
20	Kalimantan Timur	214.833	194.287	74.704	72.622	29.566	30.729	38.927	27.902
21	Kalimantan Utara	40.857	36.837	14.404	14.186	7.038	6.833	4.046	3.623
22	Sulawesi Utara	141.079	127.936	59.134	57.546	25.447	25.324	22.907	22.680
23	Gorontalo	71.636	66.887	23.375	24.959	12.229	11.416	9.657	8.322
24	Sulawesi Tengah	195.458	179.614	61.305	63.091	28.968	32.167	18.409	16.897
25	Sulawesi Selatan	521.206	476.267	192.690	197.294	112.165	101.978	70.339	52.780
26	Sulawesi Barat	91.300	82.641	28.614	30.119	12.514	11.776	13.024	11.938
27	Sulawesi Tenggara	178.122	164.525	61.160	61.060	46.672	33.825	14.728	12.261
28	Maluku	123.699	111.471	47.919	46.470	31.889	31.563	9.062	7.342
29	Maluku Utara	86.885	79.243	28.968	28.351	17.339	16.529	7.737	7.113
30	Bali	213.873	196.523	101.405	92.511	41.202	37.943	44.512	36.210
31	Nusa Tenggara Barat	270.930	247.951	91.646	86.590	52.664	47.978	35.874	22.885
32	Nusa Tenggara Timur	437.175	394.724	148.526	153.270	76.306	78.780	30.197	24.335
33	Papua	214.149	176.974	60.395	48.117	26.557	24.084	14.407	8.231
34	Papua Barat	69.188	61.941	21.565	20.201	11.645	11.131	6.221	4.367
	Indonesia	13.648.353	12.483.788	5.020.313	4.910.334	2.113.835	2.118.737	2.410.550	1.800.695

Tabel : 9
Jumlah Siswa Menurut Tingkat, Jenjang Pendidikan dan Status
Tahun 2014/15

No.		Tingkat						Jumlah
		I	II	III	IV	V	VI	
(1)		(3)	(4)	(5)	(6)	(7)	(8)	(9)
1.	SD	4.504.593	4.454.341	4.346.495	4.280.608	4.312.123	4.233.981	26.132.141
	a. Negeri	3.930.546	3.903.319	3.831.761	3.806.438	3.857.351	3.809.518	23.138.933
	b. Swasta	574.047	551.022	514.734	474.170	454.772	424.463	2.993.208
2.		VII	VIII	IX				
	SMP	3.387.018	3.354.431	3.189.198				9.930.647
	a. Negeri	2.525.035	2.504.200	2.373.146				7.402.381
	b. Swasta	861.983	850.231	816.052				2.528.266
3.		X	XI	XII				
	SMA	1.456.848	1.425.590	1.350.134				4.232.572
	a. Negeri	1.081.488	1.050.090	1.008.935				3.140.513
	b. Swasta	375.360	375.500	341.199				1.092.059
4.	SMK	1.447.201	1.395.180	1.368.864				4.211.245
	a. Negeri	614.453	573.746	560.139				1.748.338
	b. Swasta	832.748	821.434	808.725				2.462.907

Grafik : 4
Jumlah Siswa menurut Tingkat dan Status sekolah
Tahun 2014/15

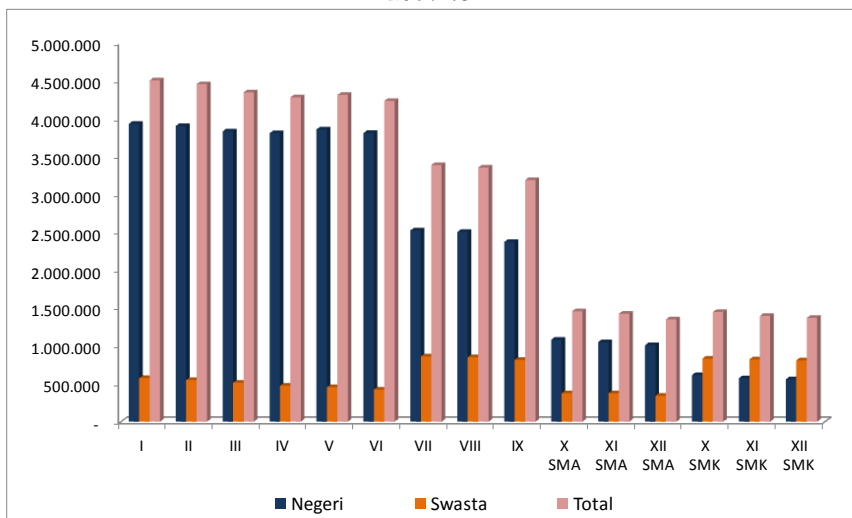
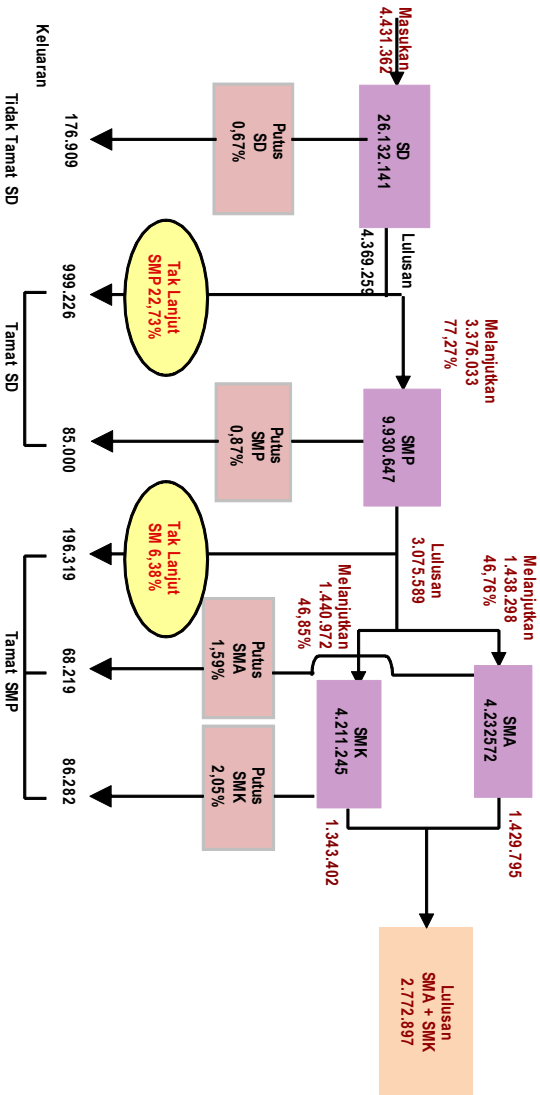

DIAGRAM 1
ARUS SISWA SEKOLAH DASAR SAMPAI SEKOLAH MENENGAH
TAHUN 2014/2015



Tabel : 10
Jumlah Siswa Putus Sekolah Jenjang Sekolah Dasar
Menurut Tingkat Tiap Provinsi
Tahun 2014/15

No.	Provinsi	I	II	III	IV	V	VI	Jumlah
(1)	(2)	(3)	(4)	(5)	(6)	(7)	(8)	(9)
1	DKI Jakarta	975	1.324	1.239	1.128	974	576	6.216
2	Jawa Barat	5.819	7.383	6.530	5.985	5.938	3.285	34.940
3	Banten	1.555	1.694	1.456	1.276	1.221	709	7.911
4	Jawa Tengah	2.047	1.984	1.760	1.566	1.451	611	9.419
5	DI Yogyakarta	193	213	202	203	144	42	997
6	Jawa Timur	1.874	2.154	1.957	1.900	1.734	968	10.587
7	Aceh	881	812	762	701	690	354	4.200
8	Sumatera Utara	2.852	2.735	2.450	2.208	2.079	1.175	13.499
9	Sumatera Barat	896	832	750	701	653	230	4.062
10	Riau	1.211	1.437	1.230	1.089	1.066	454	6.487
11	Kep. Riau	278	329	265	266	267	104	1.509
12	Jambi	845	931	746	705	671	353	4.251
13	Sumatera Selatan	1.844	1.544	1.212	1.126	1.108	693	7.527
14	Bangka Belitung	207	182	153	169	134	70	915
15	Bengkulu	403	352	298	265	241	119	1.678
16	Lampung	1.191	1.065	876	899	888	533	5.452
17	Kalimantan Barat	1.090	886	705	675	688	400	4.444
18	Kalimantan Tengah	718	677	577	528	506	262	3.268
19	Kalimantan Selatan	542	578	560	500	412	227	2.819
20	Kalimantan Timur	693	778	628	622	527	211	3.459
21	Kalimantan Utara	124	113	118	100	99	56	610
22	Sulawesi Utara	514	485	404	380	341	208	2.332
23	Gorontalo	206	212	176	207	233	75	1.109
24	Sulawesi Tengah	629	761	564	563	541	345	3.403
25	Sulawesi Selatan	1.461	1.721	1.552	1.560	1.502	1.261	9.057
26	Sulawesi Barat	270	325	297	265	249	300	1.706
27	Sulawesi Tenggara	806	742	623	629	669	556	4.025
28	Maluku	584	398	305	264	306	399	2.256
29	Maluku Utara	547	378	261	243	313	209	1.951
30	Bali	258	313	252	254	237	112	1.426
31	Nusa Tenggara Barat	673	614	433	454	416	300	2.890
32	Nusa Tenggara Timur	1.533	1.182	809	715	757	495	5.491
33	Papua	1.191	954	853	766	646	503	4.913
34	Papua Barat	478	428	345	286	305	258	2.100
	Indonesia	35.388	36.516	31.348	29.198	28.006	16.453	176.909

Tabel : 11
Jumlah Siswa Putus Sekolah Jenjang Sekolah Menengah Pertama
Menurut Tingkat Tiap Provinsi
Tahun 2014/15

No.	Provinsi	VII	VIII	IX	Jumlah
(1)	(2)	(3)	(4)	(5)	(6)
1	DKI Jakarta	1.112	1.036	568	2.716
2	Jawa Barat	5.861	6.883	6.570	19.314
3	Banten	1.242	1.548	1.095	3.885
4	Jawa Tengah	2.277	2.371	1.546	6.194
5	DI Yogyakarta	132	129	101	362
6	Jawa Timur	2.841	3.292	2.431	8.564
7	Aceh	790	960	715	2.465
8	Sumatera Utara	1.334	1.804	1.571	4.709
9	Sumatera Barat	594	592	296	1.482
10	R i a u	640	719	407	1.766
11	Kep. Riau	232	205	109	546
12	J a m b i	369	590	345	1.304
13	Sumatera Selatan	781	931	703	2.415
14	Bangka Belitung	159	185	61	405
15	Bengkulu	186	301	157	644
16	Lampung	751	1.050	1.024	2.825
17	Kalimantan Barat	643	845	488	1.976
18	Kalimantan Tengah	506	551	297	1.354
19	Kalimantan Selatan	269	332	220	821
20	Kalimantan Timur	476	520	245	1.241
21	Kalimantan Utara	117	155	135	407
22	Sulawesi Utara	298	396	409	1.103
23	Gorontalo	134	169	95	398
24	Sulawesi Tengah	356	465	344	1.165
25	Sulawesi Selatan	1.082	1.723	1.832	4.637
26	Sulawesi Barat	257	302	337	896
27	Sulawesi Tenggara	429	515	650	1.594
28	M a l u k u	258	307	355	920
29	Maluku Utara	163	313	238	714
30	B a l i	364	357	263	984
31	Nusa Tenggara Barat	434	537	496	1.467
32	Nusa Tenggara Timur	1.169	1.391	930	3.490
33	Papua	489	631	473	1.593
34	Papua Barat	161	272	211	644
	Indonesia	26.906	32.377	25.717	85.000

Tabel : 12
Jumlah Siswa Putus Sekolah Jenjang Sekolah Menengah Atas
Menurut Tingkat Tiap Provinsi
Tahun 2014/15

No.	Provinsi	X	XI	XII	Jumlah
(1)	(2)	(3)	(4)	(5)	(6)
1	DKI Jakarta	692	430	128	1.250
2	Jawa Barat	3.889	3.071	1.211	8.171
3	Banten	1.186	942	387	2.515
4	Jawa Tengah	1.832	1.378	871	4.081
5	DI Yogyakarta	171	113	33	317
6	Jawa Timur	2.628	2.364	1.174	6.166
7	Aceh	1.261	1.036	480	2.777
8	Sumatera Utara	2.418	1.954	1.367	5.739
9	Sumatera Barat	1.508	762	273	2.543
10	R i a u	922	719	337	1.978
11	Kep. Riau	208	155	48	411
12	J a m b i	365	302	131	798
13	Sumatera Selatan	1.580	1.416	617	3.613
14	Bangka Belitung	189	126	51	366
15	Bengkulu	282	336	149	767
16	Lampung	1.016	711	415	2.142
17	Kalimantan Barat	1.009	837	344	2.190
18	Kalimantan Tengah	537	442	260	1.239
19	Kalimantan Selatan	385	343	170	898
20	Kalimantan Timur	447	439	219	1.105
21	Kalimantan Utara	93	27	47	167
22	Sulawesi Utara	413	375	129	917
23	Gorontalo	363	286	95	744
24	Sulawesi Tengah	714	506	229	1.449
25	Sulawesi Selatan	1.574	1.252	769	3.595
26	Sulawesi Barat	204	140	81	425
27	Sulawesi Tenggara	800	768	628	2.196
28	M a l u k u	388	365	174	927
29	Maluku Utara	246	248	201	695
30	B a l i	371	245	194	810
31	Nusa Tenggara Barat	842	936	675	2.453
32	Nusa Tenggara Timur	1.571	1.234	393	3.198
33	Papua	367	336	170	873
34	Papua Barat	241	220	243	704
	Indonesia	30.712	24.814	12.693	68.219

Tabel : 13
Jumlah Siswa Putus Sekolah Jenjang Sekolah Menengah Kejuruan
Menurut Tingkat Tiap Provinsi
Tahun 2014/15

No.	Provinsi	X	XI	XII	Jumlah
(1)	(2)	(3)	(4)	(5)	(6)
1	DKI Jakarta	1.346	973	332	2.651
2	Jawa Barat	6.030	6.645	3.056	15.731
3	Banten	1.473	1.688	1.111	4.272
4	Jawa Tengah	4.677	5.114	2.291	12.082
5	DI Yogyakarta	442	289	205	936
6	Jawa Timur	4.658	5.031	2.381	12.070
7	Aceh	313	333	205	851
8	Sumatera Utara	3.098	3.542	2.259	8.899
9	Sumatera Barat	1.161	491	217	1.869
10	R i a u	546	672	304	1.522
11	Kep. Riau	200	119	31	350
12	J a m b i	287	348	146	781
13	Sumatera Selatan	914	828	420	2.162
14	Bangka Belitung	246	196	71	513
15	Bengkulu	235	227	126	588
16	Lampung	1.003	1.071	637	2.711
17	Kalimantan Barat	597	563	259	1.419
18	Kalimantan Tengah	290	276	127	693
19	Kalimantan Selatan	356	555	332	1.243
20	Kalimantan Timur	586	744	298	1.628
21	Kalimantan Utara	3	21	8	32
22	Sulawesi Utara	343	473	219	1.035
23	Gorontalo	300	186	87	573
24	Sulawesi Tengah	315	539	217	1.071
25	Sulawesi Selatan	1.062	1.108	742	2.912
26	Sulawesi Barat	154	405	101	660
27	Sulawesi Tenggara	478	523	364	1.365
28	M a l u k u	109	146	47	302
29	Maluku Utara	47	198	158	403
30	B a l i	255	433	224	912
31	Nusa Tenggara Barat	429	717	584	1.730
32	Nusa Tenggara Timur	654	597	357	1.608
33	Papua	122	135	130	387
34	Papua Barat	70	153	98	321
	Indonesia	32.799	35.339	18.144	86.282

Grafik : 5
Grafik Siswa Putus Sekolah Menurut Jenis Kelamin
Tahun 2014/15

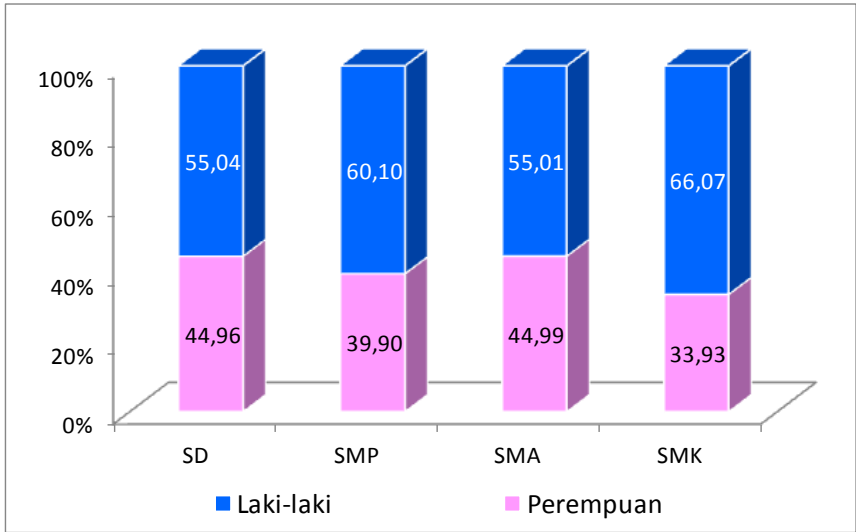

Grafik : 6
Grafik Mengulang Menurut Jenis Kelamin
Tahun 2014/15

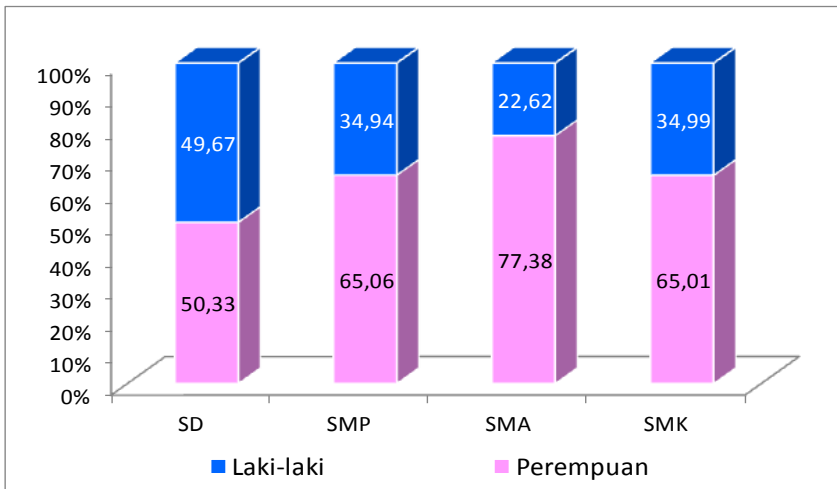

Tabel : 14
Jumlah Siswa Mengulang Jenjang Sekolah Dasar
Menurut Tingkat Tiap Provinsi
Tahun 2014/15

No.	Provinsi	I	II	III	IV	V	VI	Jumlah
(1)	(2)	(3)	(4)	(5)	(6)	(7)	(8)	(9)
1	DKI Jakarta	6.789	1.250	1.226	1.130	834	42	11.271
2	Jawa Barat	13.950	7.054	5.307	3.646	2.564	156	32.677
3	Banten	5.626	4.201	2.858	1.790	1.051	46	15.572
4	Jawa Tengah	7.216	13.435	12.267	10.207	6.775	84	49.984
5	DI Yogyakarta	645	816	792	796	627	41	3.717
6	Jawa Timur	6.527	9.759	7.585	5.791	3.599	135	33.396
7	Aceh	1.230	2.198	1.949	1.456	920	71	7.824
8	Sumatera Utara	2.952	5.059	3.801	2.322	1.266	88	15.488
9	Sumatera Barat	1.797	4.671	4.697	4.425	3.470	83	19.143
10	Riau	2.205	1.724	1.586	1.381	1.113	84	8.093
11	Kep. Riau	526	790	786	688	540	91	3.421
12	Jambi	1.108	2.259	1.731	1.082	697	44	6.921
13	Sumatera Selatan	2.127	3.851	2.810	1.695	913	120	11.516
14	Bangka Belitung	340	1.550	1.552	1.302	949	70	5.763
15	Bengkulu	592	1.375	1.116	793	541	47	4.464
16	Lampung	1.569	2.977	2.539	1.741	1.080	109	10.015
17	Kalimantan Barat	1.426	6.625	5.199	3.884	2.636	38	19.808
18	Kalimantan Tengah	1.748	1.630	1.231	793	464	45	5.911
19	Kalimantan Selatan	1.207	2.970	2.244	1.587	956	94	9.058
20	Kalimantan Timur	2.090	2.201	1.778	1.324	848	69	8.310
21	Kalimantan Utara	297	530	380	261	170	11	1.649
22	Sulawesi Utara	737	910	609	385	299	92	3.032
23	Gorontalo	466	1.541	1.179	1.021	714	20	4.922
24	Sulawesi Tengah	1.109	2.870	2.129	1.421	979	59	8.567
25	Sulawesi Selatan	2.194	5.071	3.883	2.550	1.821	46	15.565
26	Sulawesi Barat	333	1.190	847	540	351	17	3.278
27	Sulawesi Tenggara	897	1.877	1.608	1.206	862	72	6.522
28	Maluku	455	377	291	172	103	47	1.445
29	Maluku Utara	351	654	413	284	161	41	1.904
30	Bali	586	1.266	948	604	239	103	3.746
31	Nusa Tenggara Barat	864	2.330	1.897	1.301	945	68	7.405
32	Nusa Tenggara Timur	1.781	8.470	6.624	4.618	2.766	216	24.475
33	Papua	1.128	2.009	1.742	1.057	727	228	6.891
34	Papua Barat	363	1.150	748	540	400	188	3.389
	Indonesia	73.231	106.640	86.352	63.774	42.380	2.765	375.142

Tabel : 15
Jumlah Siswa Mengulang Jenjang Sekolah Menengah Pertama
Menurut Tingkat Tiap Provinsi
Tahun 2014/15

No.	Provinsi	VII	VIII	IX	Jumlah
(1)	(2)	(3)	(4)	(5)	(6)
1	DKI Jakarta	464	364	111	939
2	Jawa Barat	472	384	181	1.037
3	Banten	332	292	122	746
4	Jawa Tengah	772	536	375	1.683
5	DI Yogyakarta	112	89	57	258
6	Jawa Timur	725	555	315	1.595
7	Aceh	350	368	204	922
8	Sumatera Utara	784	417	216	1.417
9	Sumatera Barat	502	363	96	961
10	Riau	596	353	108	1.057
11	Kep. Riau	182	110	39	331
12	Jambi	335	261	73	669
13	Sumatera Selatan	530	481	215	1.226
14	Bangka Belitung	168	122	38	328
15	Bengkulu	264	185	59	508
16	Lampung	344	320	163	827
17	Kalimantan Barat	408	342	172	922
18	Kalimantan Tengah	135	98	27	260
19	Kalimantan Selatan	245	183	54	482
20	Kalimantan Timur	155	79	31	265
21	Kalimantan Utara	31	53	16	100
22	Sulawesi Utara	164	120	54	338
23	Gorontalo	131	97	72	300
24	Sulawesi Tengah	326	206	124	656
25	Sulawesi Selatan	453	271	188	912
26	Sulawesi Barat	104	57	26	187
27	Sulawesi Tenggara	312	206	179	697
28	Maluku	241	176	94	511
29	Maluku Utara	148	97	54	299
30	Bali	104	42	15	161
31	Nusa Tenggara Barat	283	166	124	573
32	Nusa Tenggara Timur	376	225	199	800
33	Papua	315	228	167	710
34	Papua Barat	122	93	39	254
	Indonesia	10.985	7.939	4.007	22.931

Tabel : 16
Jumlah Siswa Mengulang Jenjang Sekolah Menengah Atas
Menurut Tingkat Tiap Provinsi
Tahun 2014/15

No.	Provinsi	X	XI	XII	Jumlah
(1)	(2)	(3)	(4)	(5)	(6)
1	DKI Jakarta	919	515	106	1.540
2	Jawa Barat	906	447	98	1.451
3	Banten	419	94	24	537
4	Jawa Tengah	1.037	525	137	1.699
5	DI Yogyakarta	357	65	39	461
6	Jawa Timur	850	528	109	1.487
7	Aceh	730	219	110	1.059
8	Sumatera Utara	888	246	92	1.226
9	Sumatera Barat	747	437	91	1.275
10	Riau	715	215	65	995
11	Kep. Riau	263	35	13	311
12	Jambi	392	73	41	506
13	Sumatera Selatan	630	211	51	892
14	Bangka Belitung	234	52	17	303
15	Bengkulu	221	52	20	293
16	Lampung	503	189	50	742
17	Kalimantan Barat	1.228	391	89	1.708
18	Kalimantan Tengah	250	26	32	308
19	Kalimantan Selatan	365	155	36	556
20	Kalimantan Timur	362	103	30	495
21	Kalimantan Utara	231	59	19	309
22	Sulawesi Utara	305	57	19	381
23	Gorontalo	245	21	19	285
24	Sulawesi Tengah	779	201	62	1.042
25	Sulawesi Selatan	808	291	107	1.206
26	Sulawesi Barat	208	108	13	329
27	Sulawesi Tenggara	464	118	35	617
28	Maluku	342	89	41	472
29	Maluku Utara	303	61	44	408
30	Bali	209	63	8	280
31	Nusa Tenggara Barat	534	145	82	761
32	Nusa Tenggara Timur	918	336	96	1.350
33	Papua	844	361	98	1.303
34	Papua Barat	344	91	26	461
	Indonesia	18.550	6.579	1.919	27.048

Tabel : 17
Jumlah Siswa Mengulang Jenjang Sekolah Menengah Kejuruan
Menurut Tingkat Tiap Provinsi
Tahun 2014/15

No.	Provinsi	X	XI	XII	Jumlah
(1)	(2)	(3)	(4)	(5)	(6)
1	DKI Jakarta	256	677	122	1.055
2	Jawa Barat	1.145	4.502	1.229	6.876
3	Banten	280	1.210	367	1.857
4	Jawa Tengah	888	3.518	894	5.300
5	DI Yogyakarta	84	193	53	330
6	Jawa Timur	883	3.155	1.089	5.127
7	Aceh	60	106	146	312
8	Sumatera Utara	588	2.165	1.014	3.767
9	Sumatera Barat	220	138	93	451
10	R i a u	104	319	205	628
11	Kep. Riau	38	45	24	107
12	J a m b i	54	157	97	308
13	Sumatera Selatan	173	448	189	810
14	Bangka Belitung	47	72	57	176
15	Bengkulu	45	63	98	206
16	Lampung	191	670	258	1.119
17	Kalimantan Barat	113	213	190	516
18	Kalimantan Tengah	56	79	112	247
19	Kalimantan Selatan	68	243	207	518
20	Kalimantan Timur	111	376	205	692
21	Kalimantan Utara	-	5	11	16
22	Sulawesi Utara	65	205	161	431
23	Gorontalo	57	63	38	158
24	Sulawesi Tengah	60	263	150	473
25	Sulawesi Selatan	202	491	390	1.083
26	Sulawesi Barat	29	269	33	331
27	Sulawesi Tenggara	90	195	210	495
28	M a l u k u	21	33	60	114
29	Maluku Utara	9	55	142	206
30	B a l i	48	245	123	416
31	Nusa Tenggara Barat	82	269	396	747
32	Nusa Tenggara Timur	124	309	153	586
33	Papua	24	83	49	156
34	Papua Barat	14	97	42	153
	Indonesia	6.229	20.931	8.607	35.767

Grafik : 7
Perkembangan Jumlah Siswa Putus Sekolah Menurut Jenjang Pendidikan Tahun 2014/15

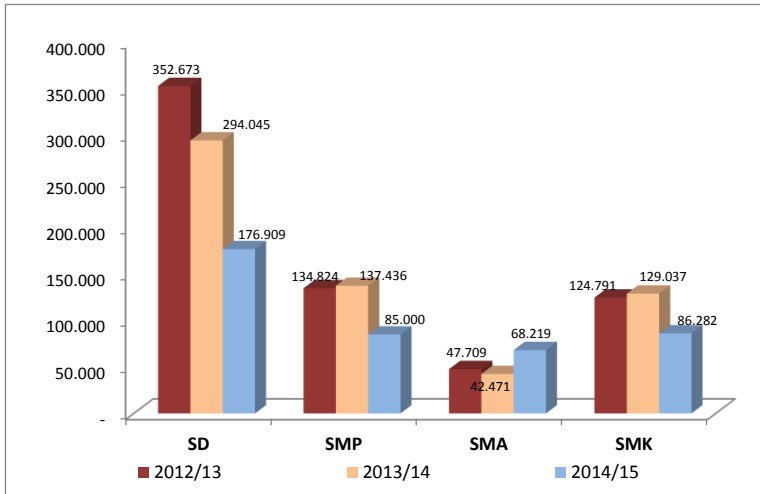

Grafik : 8
Perkembangan Jumlah Siswa Mengulang Menurut Jenjang Pendidikan Tahun 2014/15

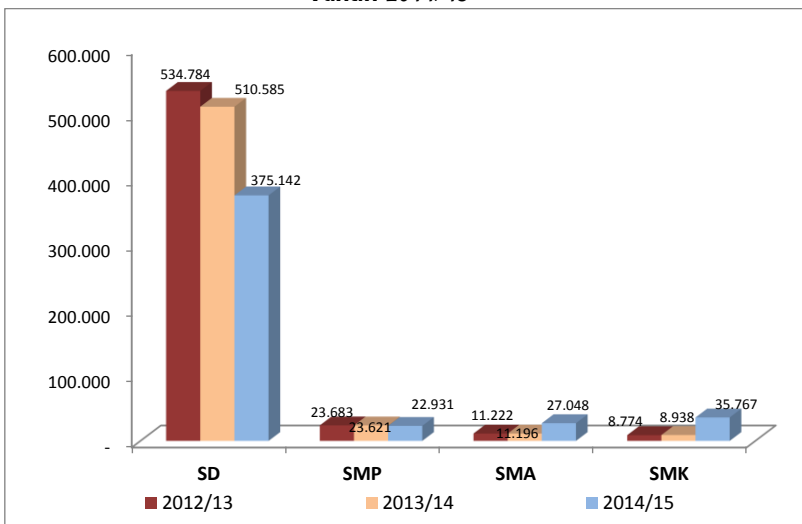

Tabel : 18
Jumlah Kepala Sekolah + Guru Taman Kanak-kanak
Menurut Ijazah Tertinggi Tiap Provinsi
Tahun 2014/15

No.	Provinsi	< S1	> S1	JUMLAH	PERSENTASE	
					< S1	> = S1
(1)	(2)	(3)	(4)	(5)	(6)	(7)
1	DKI Jakarta	2.928	4.911	7.839	37,35	62,65
2	Jawa Barat	16.742	18.855	35.597	47,03	52,97
3	Banten	3.251	4.803	8.054	40,37	59,63
4	Jawa Tengah	29.224	28.857	58.081	50,32	49,68
5	DI Yogyakarta	2.931	5.661	8.592	34,11	65,89
6	Jawa Timur	29.915	46.538	76.453	39,13	60,87
7	Aceh	6.905	3.752	10.657	64,79	35,21
8	Sumatera Utara	3.479	5.318	8.797	39,55	60,45
9	Sumatera Barat	4.777	3.980	8.757	54,55	45,45
10	R i a u	3.864	2.193	6.057	63,79	36,21
11	Kep. Riau	1.871	717	2.588	72,30	27,70
12	J a m b i	2.951	1.696	4.647	63,50	36,50
13	Sumatera Selatan	4.662	3.161	7.823	59,59	40,41
14	Bangka Belitung	1.273	854	2.127	59,85	40,15
15	Bengkulu	1.758	2.099	3.857	45,58	54,42
16	Lampung	6.767	6.309	13.076	51,75	48,25
17	Kalimantan Barat	1.966	1.592	3.558	55,26	44,74
18	Kalimantan Tengah	3.773	2.829	6.602	57,15	42,85
19	Kalimantan Selatan	5.995	5.558	11.553	51,89	48,11
20	Kalimantan Timur	3.485	3.947	7.432	46,89	53,11
21	Kalimantan Utara	762	288	1.050	72,57	27,43
22	Sulawesi Utara	2.366	1.166	3.532	66,99	33,01
23	Gorontalo	1.411	1.135	2.546	55,42	44,58
24	Sulawesi Tengah	4.305	1.649	5.954	72,30	27,70
25	Sulawesi Selatan	6.810	10.918	17.728	38,41	61,59
26	Sulawesi Barat	1.634	773	2.407	67,89	32,11
27	Sulawesi Tenggara	4.464	2.285	6.749	66,14	33,86
28	M a l u k u	835	243	1.078	77,46	22,54
29	Maluku Utara	1.012	430	1.442	70,18	29,82
30	B a l i	2.932	4.236	7.168	40,90	59,10
31	Nusa Tenggara Barat	3.739	4.967	8.706	42,95	57,05
32	Nusa Tenggara Timur	2.725	1.003	3.728	73,10	26,90
33	Papua	1.110	537	1.647	67,40	32,60
34	Papua Barat	682	398	1.080	63,15	36,85
	Indonesia	173.304	183.658	356.962	48,55	51,45

Tabel : 19
Jumlah Kepala Sekolah + Guru Sekolah Luar Biasa
Menurut Ijazah Tertinggi Tiap Provinsi
Tahun 2014/15

No.	Provinsi	< S1	> S1	JUMLAH	PERSENTASE	
					< S1	> = S1
(1)	(2)	(3)	(4)	(5)	(6)	(7)
1	DKI Jakarta	310	1.060	1.370	22,63	77,37
2	Jawa Barat	972	4.472	5.444	17,85	82,15
3	Banten	319	857	1.176	27,13	72,87
4	Jawa Tengah	773	2.728	3.501	22,08	77,92
5	DI Yogyakarta	315	1.307	1.622	19,42	80,58
6	Jawa Timur	870	3.994	4.864	17,89	82,11
7	Aceh	265	666	931	28,46	71,54
8	Sumatera Utara	186	548	734	25,34	74,66
9	Sumatera Barat	431	1.213	1.644	26,22	73,78
10	R i a u	191	426	617	30,96	69,04
11	Kep. Riau	63	169	232	27,16	72,84
12	J a m b i	102	265	367	27,79	72,21
13	Sumatera Selatan	125	412	537	23,28	76,72
14	Bangka Belitung	123	111	234	52,56	47,44
15	Bengkulu	93	219	312	29,81	70,19
16	Lampung	182	256	438	41,55	58,45
17	Kalimantan Barat	85	177	262	32,44	67,56
18	Kalimantan Tengah	40	225	265	15,09	84,91
19	Kalimantan Selatan	140	595	735	19,05	80,95
20	Kalimantan Timur	125	320	445	28,09	71,91
21	Kalimantan Utara	25	32	57	43,86	56,14
22	Sulawesi Utara	53	205	258	20,54	79,46
23	Gorontalo	53	171	224	23,66	76,34
24	Sulawesi Tengah	115	199	314	36,62	63,38
25	Sulawesi Selatan	400	984	1.384	28,90	71,10
26	Sulawesi Barat	157	166	323	48,61	51,39
27	Sulawesi Tenggara	239	410	649	36,83	63,17
28	M a l u k u	70	84	154	45,45	54,55
29	Maluku Utara	78	154	232	33,62	66,38
30	B a l i	68	364	432	15,74	84,26
31	Nusa Tenggara Barat	232	587	819	28,33	71,67
32	Nusa Tenggara Timur	263	486	749	35,11	64,89
33	Papua	18	43	61	29,51	70,49
34	Papua Barat	11	24	35	31,43	68,57
	Indonesia	7.492	23.929	31.421	23,84	76,16

Tabel : 20
Jumlah Kepala Sekolah + Guru Sekolah Dasar
Menurut Ijazah Tertinggi Tiap Provinsi
Tahun 2014/15

No.	Provinsi	< S1	> S1	JUMLAH	PERSENTASE	
					< S1	> = S1
(1)	(2)	(3)	(4)	(5)	(6)	(7)
1	DKI Jakarta	6.862	37.193	44.055	15,58	84,42
2	Jawa Barat	26.972	220.721	247.693	10,89	89,11
3	Banten	9.341	54.993	64.334	14,52	85,48
4	Jawa Tengah	25.595	201.441	227.036	11,27	88,73
5	DI Yogyakarta	3.457	21.230	24.687	14,00	86,00
6	Jawa Timur	26.569	216.275	242.844	10,94	89,06
7	Aceh	15.642	37.189	52.831	29,61	70,39
8	Sumatera Utara	35.811	85.998	121.809	29,40	70,60
9	Sumatera Barat	7.172	43.624	50.796	14,12	85,88
10	R i a u	11.438	43.128	54.566	20,96	79,04
11	Kep. Riau	2.366	11.260	13.626	17,36	82,64
12	J a m b i	8.780	21.576	30.356	28,92	71,08
13	Sumatera Selatan	16.967	48.313	65.280	25,99	74,01
14	Bangka Belitung	2.163	7.628	9.791	22,09	77,91
15	Bengkulu	3.917	13.444	17.361	22,56	77,44
16	Lampung	15.831	46.094	61.925	25,56	74,44
17	Kalimantan Barat	14.770	30.182	44.952	32,86	67,14
18	Kalimantan Tengah	7.162	20.572	27.734	25,82	74,18
19	Kalimantan Selatan	5.980	27.966	33.946	17,62	82,38
20	Kalimantan Timur	5.963	21.245	27.208	21,92	78,08
21	Kalimantan Utara	2.110	3.982	6.092	34,64	65,36
22	Sulawesi Utara	7.147	14.473	21.620	33,06	66,94
23	Gorontalo	1.908	7.872	9.780	19,51	80,49
24	Sulawesi Tengah	11.721	19.139	30.860	37,98	62,02
25	Sulawesi Selatan	13.212	66.666	79.878	16,54	83,46
26	Sulawesi Barat	5.105	9.299	14.404	35,44	64,56
27	Sulawesi Tenggara	7.123	19.600	26.723	26,65	73,35
28	M a l u k u	9.638	9.861	19.499	49,43	50,57
29	Maluku Utara	6.637	5.406	12.043	55,11	44,89
30	B a l i	3.204	25.914	29.118	11,00	89,00
31	Nusa Tenggara Barat	9.127	34.602	43.729	20,87	79,13
32	Nusa Tenggara Timur	25.156	33.688	58.844	42,75	57,25
33	Papua	10.416	8.796	19.212	54,22	45,78
34	Papua Barat	3.245	4.985	8.230	39,43	60,57
	Indonesia	368.507	1.474.355	1.842.862	20,00	80,00

Tabel : 21
Jumlah Kepala Sekolah + Guru Sekolah Menengah Pertama
Menurut Ijazah Tertinggi Tiap Provinsi
Tahun 2014/15

No.	Provinsi	< S1	> S1	JUMLAH	PERSENTASE	
					< S1	> = S1
(1)	(2)	(3)	(4)	(5)	(6)	(7)
1	DKI Jakarta	4.138	20.827	24.965	16,58	83,42
2	Jawa Barat	17.401	93.078	110.479	15,75	84,25
3	Banten	4.931	22.623	27.554	17,90	82,10
4	Jawa Tengah	8.680	77.378	86.058	10,09	89,91
5	DI Yogyakarta	1.600	9.902	11.502	13,91	86,09
6	Jawa Timur	11.794	91.727	103.521	11,39	88,61
7	Aceh	3.835	21.541	25.376	15,11	84,89
8	Sumatera Utara	9.322	44.995	54.317	17,16	82,84
9	Sumatera Barat	3.405	18.035	21.440	15,88	84,12
10	R i a u	3.381	17.936	21.317	15,86	84,14
11	Kep. Riau	752	4.528	5.280	14,24	85,76
12	J a m b i	1.598	10.579	12.177	13,12	86,88
13	Sumatera Selatan	4.835	24.816	29.651	16,31	83,69
14	Bangka Belitung	529	2.963	3.492	15,15	84,85
15	Bengkulu	1.132	7.016	8.148	13,89	86,11
16	Lampung	5.827	23.198	29.025	20,08	79,92
17	Kalimantan Barat	3.724	13.747	17.471	21,32	78,68
18	Kalimantan Tengah	1.382	9.099	10.481	13,19	86,81
19	Kalimantan Selatan	1.106	9.784	10.890	10,16	89,84
20	Kalimantan Timur	1.377	9.556	10.933	12,59	87,41
21	Kalimantan Utara	388	2.068	2.456	15,80	84,20
22	Sulawesi Utara	2.714	8.526	11.240	24,15	75,85
23	Gorontalo	648	4.109	4.757	13,62	86,38
24	Sulawesi Tengah	1.646	10.621	12.267	13,42	86,58
25	Sulawesi Selatan	4.541	31.917	36.458	12,46	87,54
26	Sulawesi Barat	978	4.441	5.419	18,05	81,95
27	Sulawesi Tenggara	1.356	10.960	12.316	11,01	88,99
28	M a l u k u	3.221	6.001	9.222	34,93	65,07
29	Maluku Utara	1.304	4.574	5.878	22,18	77,82
30	B a l i	2.058	11.851	13.909	14,80	85,20
31	Nusa Tenggara Barat	3.056	17.393	20.449	14,94	85,06
32	Nusa Tenggara Timur	5.546	19.822	25.368	21,86	78,14
33	Papua	1.922	6.488	8.410	22,85	77,15
34	Papua Barat	473	3.261	3.734	12,67	87,33
Indonesia		120.600	675.360	795.960	15,15	84,85

Tabel : 22
Jumlah Kepala Sekolah + Guru Sekolah Menengah Atas
Menurut Ijazah Tertinggi Tiap Provinsi
Tahun 2014/15

No.	Provinsi	< S1	> S1	JUMLAH	PERSENTASE	
					< S1	> = S1
(1)	(2)	(3)	(4)	(5)	(6)	(7)
1	DKI Jakarta	660	12.854	13.514	4,88	95,12
2	Jawa Barat	1.604	40.396	42.000	3,82	96,18
3	Banten	583	11.840	12.423	4,69	95,31
4	Jawa Tengah	1.561	27.843	29.404	5,31	94,69
5	DI Yogyakarta	357	4.894	5.251	6,80	93,20
6	Jawa Timur	1.890	39.901	41.791	4,52	95,48
7	Aceh	846	14.320	15.166	5,58	94,42
8	Sumatera Utara	1.707	26.355	28.062	6,08	93,92
9	Sumatera Barat	743	11.999	12.742	5,83	94,17
10	Riau	579	10.904	11.483	5,04	94,96
11	Kep. Riau	148	2.439	2.587	5,72	94,28
12	Jambi	516	5.483	5.999	8,60	91,40
13	Sumatera Selatan	1.398	16.541	17.939	7,79	92,21
14	Bangka Belitung	101	1.606	1.707	5,92	94,08
15	Bengkulu	282	3.907	4.189	6,73	93,27
16	Lampung	1.142	12.165	13.307	8,58	91,42
17	Kalimantan Barat	341	7.561	7.902	4,32	95,68
18	Kalimantan Tengah	262	4.470	4.732	5,54	94,46
19	Kalimantan Selatan	408	4.493	4.901	8,32	91,68
20	Kalimantan Timur	98	4.846	4.944	1,98	98,02
21	Kalimantan Utara	83	1.132	1.215	6,83	93,17
22	Sulawesi Utara	272	4.299	4.571	5,95	94,05
23	Gorontalo	75	1.515	1.590	4,72	95,28
24	Sulawesi Tengah	350	4.306	4.656	7,52	92,48
25	Sulawesi Selatan	1.332	16.072	17.404	7,65	92,35
26	Sulawesi Barat	130	1.674	1.804	7,21	92,79
27	Sulawesi Tenggara	545	6.586	7.131	7,64	92,36
28	Maluku	392	5.404	5.796	6,76	93,24
29	Maluku Utara	249	3.052	3.301	7,54	92,46
30	Bali	459	6.326	6.785	6,76	93,24
31	Nusa Tenggara Barat	489	9.740	10.229	4,78	95,22
32	Nusa Tenggara Timur	242	11.725	11.967	2,02	97,98
33	Papua	353	3.786	4.139	8,53	91,47
34	Papua Barat	219	1.843	2.062	10,62	89,38
	Indonesia	20.416	342.277	362.693	5,63	94,37

Tabel : 23
Jumlah Kepala Sekolah + Guru Sekolah Menengah Kejuruan
Menurut Ijazah Tertinggi Tiap Provinsi
Tahun 2014/15

No.	Provinsi	< S1	> S1	JUMLAH	PERSENTASE	
					< S1	> = S1
(1)	(2)	(3)	(4)	(5)	(6)	(7)
1	DKI Jakarta	1.682	14.269	15.951	10,54	89,46
2	Jawa Barat	15.753	48.857	64.610	24,38	75,62
3	Banten	3.151	12.650	15.801	19,94	80,06
4	Jawa Tengah	5.640	44.218	49.858	11,31	88,69
5	DI Yogyakarta	749	7.387	8.136	9,21	90,79
6	Jawa Timur	3.669	49.794	53.463	6,86	93,14
7	Aceh	971	5.228	6.199	15,66	84,34
8	Sumatera Utara	3.418	21.699	25.117	13,61	86,39
9	Sumatera Barat	589	7.698	8.287	7,11	92,89
10	R i a u	1.028	6.192	7.220	14,24	85,76
11	Kep. Riau	312	1.793	2.105	14,82	85,18
12	J a m b i	441	3.772	4.213	10,47	89,53
13	Sumatera Selatan	1.598	6.797	8.395	19,04	80,96
14	Bangka Belitung	310	1.415	1.725	17,97	82,03
15	Bengkulu	355	2.412	2.767	12,83	87,17
16	Lampung	2.914	8.593	11.507	25,32	74,68
17	Kalimantan Barat	845	3.352	4.197	20,13	79,87
18	Kalimantan Tengah	340	2.494	2.834	12,00	88,00
19	Kalimantan Selatan	481	3.362	3.843	12,52	87,48
20	Kalimantan Timur	1.051	4.693	5.744	18,30	81,70
21	Kalimantan Utara	49	710	759	6,46	93,54
22	Sulawesi Utara	412	3.507	3.919	10,51	89,49
23	Gorontalo	195	1.383	1.578	12,36	87,64
24	Sulawesi Tengah	430	3.308	3.738	11,50	88,50
25	Sulawesi Selatan	1.491	11.120	12.611	11,82	88,18
26	Sulawesi Barat	374	1.835	2.209	16,93	83,07
27	Sulawesi Tenggara	428	2.992	3.420	12,51	87,49
28	M a l u k u	353	2.004	2.357	14,98	85,02
29	Maluku Utara	395	1.460	1.855	21,29	78,71
30	B a l i	1.306	5.474	6.780	19,26	80,74
31	Nusa Tenggara Barat	2.086	5.811	7.897	26,42	73,58
32	Nusa Tenggara Timur	1.136	5.042	6.178	18,39	81,61
33	Papua	345	2.354	2.699	12,78	87,22
34	Papua Barat	116	1.011	1.127	10,29	89,71
Indonesia		54.413	304.686	359.099	15,15	84,85

Grafik : 9
Persentase Kepala Sekolah + Guru Menurut Ijazah Tertinggi
Semua Jenjang Pendidikan
Tahun 2014/15

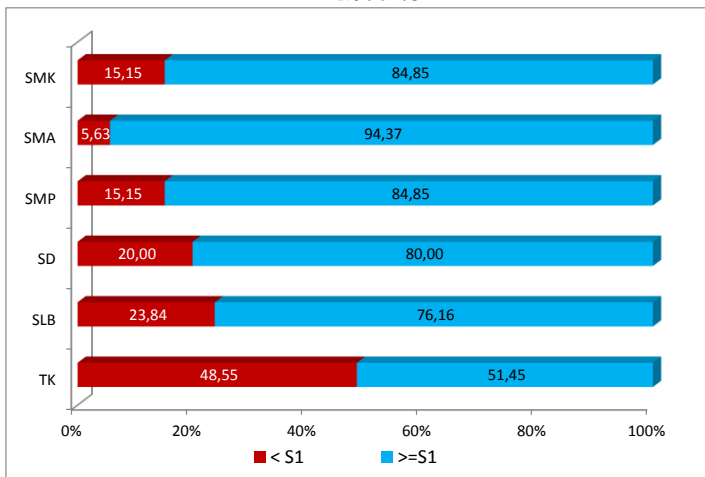

Grafik : 10
Persentase Kepala Sekolah + Guru Menurut Jabatan
Semua Jenjang Pendidikan
Tahun 2014/15

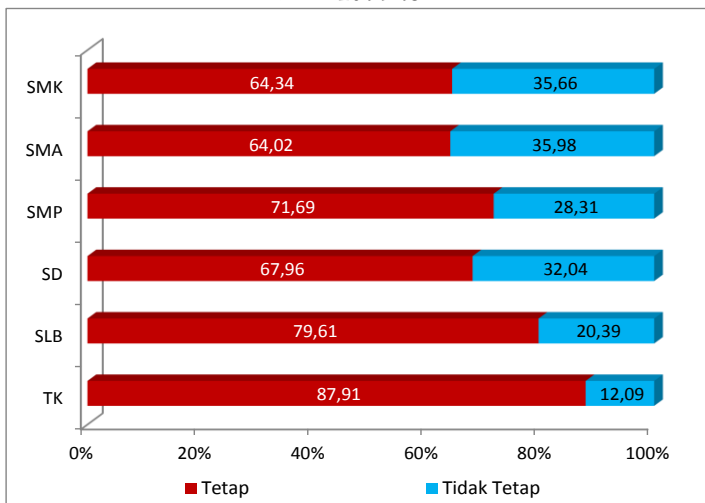

Tabel : 24
Jumlah Kepala Sekolah + Guru Menurut Status dan Jenjang Pendidikan
Tahun 2014/15

No.	Jenjang Pendidikan	Tetap	%	Tidak Tetap	%	Jumlah
(1)	(2)	(3)	(4)	(5)	(6)	(7)
1.	TK					
	a. Negeri	14.378	92,67	1.138	7,33	15.516
	b. Swasta	299.427	87,69	42.019	12,31	341.446
	Jumlah	313.805	87,91	43.157	12,09	356.962
2.	SLB					
	a. Negeri	7.272	61,54	4.544	38,46	11.816
	b. Swasta	17.741	90,49	1.864	9,51	19.605
	Jumlah	25.013	79,61	6.408	20,39	31.421
3.	SD					
	a. Negeri	1.112.904	67,99	523.914	32,01	1.636.818
	b. Swasta	139.478	67,69	66.566	32,31	206.044
	Jumlah	1.252.382	67,96	590.480	32,04	1.842.862
4.	SMP					
	a. Negeri	389.126	70,75	160.855	29,25	549.981
	b. Swasta	181.485	73,78	64.494	26,22	245.979
	Jumlah	570.611	71,69	225.349	28,31	795.960
5.	SMA					
	a. Negeri	160.059	69,25	71.076	30,75	231.135
	b. Swasta	72.149	54,84	59.409	45,16	131.558
	Jumlah	232.208	64,02	130.485	35,98	362.693
6.	SMK					
	a. Negeri	91.929	64,93	49.652	35,07	141.581
	b. Swasta	139.121	63,96	78.397	36,04	217.518
	Jumlah	231.050	64,34	128.049	35,66	359.099

Tabel : 25
Jumlah Rombongan Belajar Sekolah Dasar
Menurut Tingkat Tiap Provinsi
Tahun 2014/15

No.	Provinsi	I	II	III	IV	V	VI	Jumlah
(1)	(2)	(3)	(4)	(5)	(6)	(7)	(8)	(9)
1	DKI Jakarta	4.934	4.930	4.617	4.451	4.400	4.506	27.838
2	Jawa Barat	27.139	27.209	26.608	26.261	26.283	26.033	159.533
3	Banten	7.219	7.083	6.778	6.592	6.597	6.546	40.815
4	Jawa Tengah	21.476	21.528	21.184	20.986	21.058	20.890	127.122
5	DI Yogyakarta	2.291	2.271	2.238	2.226	2.235	2.236	13.497
6	Jawa Timur	22.716	22.727	22.398	22.377	22.561	22.406	135.185
7	Aceh	4.095	4.058	3.962	3.825	3.853	3.836	23.629
8	Sumatera Utara	12.611	12.440	12.111	11.924	11.755	11.558	72.399
9	Sumatera Barat	5.149	5.170	5.056	4.962	4.863	4.760	29.960
10	R i a u	5.883	5.692	5.438	5.341	5.246	5.066	32.666
11	Kep. Riau	1.577	1.513	1.462	1.404	1.354	1.275	8.585
12	J a m b i	3.181	3.116	3.028	2.999	2.946	2.927	18.197
13	Sumatera Selatan	6.916	6.705	6.475	6.280	6.250	6.039	38.665
14	Bangka Belitung	1.115	1.099	1.056	1.057	1.038	1.013	6.378
15	Bengkulu	1.804	1.777	1.758	1.749	1.712	1.635	10.435
16	Lampung	6.344	6.237	6.035	5.967	5.935	5.851	36.369
17	Kalimantan Barat	5.383	5.228	5.104	5.019	4.919	4.803	30.456
18	Kalimantan Tengah	2.935	2.905	2.847	2.825	2.791	2.744	17.047
19	Kalimantan Selatan	3.540	3.431	3.365	3.319	3.334	3.269	20.258
20	Kalimantan Timur	3.035	2.990	2.848	2.776	2.729	2.633	17.011
21	Kalimantan Utara	652	642	613	601	594	577	3.679
22	Sulawesi Utara	2.407	2.416	2.408	2.377	2.375	2.356	14.339
23	Gorontalo	1.066	1.075	1.048	1.034	1.024	993	6.240
24	Sulawesi Tengah	3.172	3.181	3.118	3.096	3.079	3.011	18.657
25	Sulawesi Selatan	7.618	7.728	7.557	7.529	7.506	7.450	45.388
26	Sulawesi Barat	1.486	1.496	1.473	1.451	1.455	1.428	8.789
27	Sulawesi Tenggara	2.758	2.784	2.739	2.719	2.688	2.638	16.326
28	M a l u k u	1.987	1.971	1.937	1.901	1.885	1.858	11.539
29	Maluku Utara	1.373	1.370	1.347	1.334	1.310	1.295	8.029
30	B a l i	2.824	2.851	2.809	2.780	2.783	2.790	16.837
31	Nusa Tenggara Barat	3.715	3.729	3.636	3.607	3.640	3.585	21.912
32	Nusa Tenggara Timur	6.565	6.501	6.293	6.060	5.865	5.571	36.855
33	Papua	2.822	2.744	2.666	2.571	2.470	2.364	15.637
34	Papua Barat	1.157	1.162	1.120	1.104	1.071	1.044	6.658
	Indonesia	188.945	187.759	183.132	180.504	179.604	176.986	1.096.930

Tabel : 26
Jumlah Rombongan Belajar Sekolah Menengah Pertama
Menurut Tingkat Tiap Provinsi
Tahun 2014/15

No.	Provinsi	VII	VIII	IX	Jumlah
(1)	(2)	(3)	(4)	(5)	(6)
1	DKI Jakarta	4.038	4.061	4.000	12.099
2	Jawa Barat	17.983	17.746	17.097	52.826
3	Banten	4.342	4.254	4.258	12.854
4	Jawa Tengah	13.373	13.530	13.467	40.370
5	DI Yogyakarta	1.514	1.525	1.536	4.575
6	Jawa Timur	14.572	14.714	14.321	43.607
7	Aceh	2.658	2.705	2.647	8.010
8	Sumatera Utara	7.140	6.992	6.872	21.004
9	Sumatera Barat	2.689	2.647	2.578	7.914
10	R i a u	2.980	2.893	2.791	8.664
11	Kep. Riau	875	826	791	2.492
12	J a m b i	1.577	1.550	1.512	4.639
13	Sumatera Selatan	3.731	3.631	3.539	10.901
14	Bangka Belitung	624	596	564	1.784
15	Bengkulu	1.130	1.120	1.093	3.343
16	Lampung	3.634	3.666	3.637	10.937
17	Kalimantan Barat	2.677	2.565	2.404	7.646
18	Kalimantan Tengah	1.445	1.401	1.324	4.170
19	Kalimantan Selatan	1.551	1.526	1.446	4.523
20	Kalimantan Timur	1.753	1.715	1.648	5.116
21	Kalimantan Utara	359	358	334	1.051
22	Sulawesi Utara	1.609	1.562	1.521	4.692
23	Gorontalo	690	669	663	2.022
24	Sulawesi Tengah	1.786	1.787	1.692	5.265
25	Sulawesi Selatan	4.883	4.837	4.754	14.474
26	Sulawesi Barat	770	751	720	2.241
27	Sulawesi Tenggara	1.741	1.697	1.685	5.123
28	M a l u k u	1.323	1.300	1.264	3.887
29	Maluku Utara	824	791	753	2.368
30	B a l i	2.044	2.038	1.984	6.066
31	Nusa Tenggara Barat	2.309	2.296	2.203	6.808
32	Nusa Tenggara Timur	3.963	3.764	3.442	11.169
33	Papua	1.337	1.263	1.158	3.758
34	Papua Barat	581	546	510	1.637
	Indonesia	114.505	113.322	110.208	338.035

Tabel : 27
Jumlah Rombongan Belajar Sekolah Menengah Atas
Menurut Tingkat Tiap Provinsi
Tahun 2014/15

No.	Provinsi	X	XI	XII	Jumlah
(1)	(2)	(3)	(4)	(5)	(6)
1	DKI Jakarta	1.747	1.787	1.685	5.219
2	Jawa Barat	5.974	5.685	5.255	16.914
3	Banten	1.726	1.620	1.575	4.921
4	Jawa Tengah	4.104	4.026	3.902	12.032
5	DI Yogyakarta	657	673	679	2.009
6	Jawa Timur	5.478	5.405	5.158	16.041
7	Aceh	1.724	1.668	1.679	5.071
8	Sumatera Utara	3.499	3.260	3.188	9.947
9	Sumatera Barat	1.585	1.520	1.503	4.608
10	R i a u	1.553	1.490	1.425	4.468
11	Kep. Riau	401	382	375	1.158
12	J a m b i	806	775	746	2.327
13	Sumatera Selatan	2.048	1.947	1.942	5.937
14	Bangka Belitung	265	245	229	739
15	Bengkulu	523	509	483	1.515
16	Lampung	1.548	1.499	1.472	4.519
17	Kalimantan Barat	1.146	1.108	1.068	3.322
18	Kalimantan Tengah	649	623	589	1.861
19	Kalimantan Selatan	684	644	622	1.950
20	Kalimantan Timur	739	712	647	2.098
21	Kalimantan Utara	172	171	155	498
22	Sulawesi Utara	711	708	665	2.084
23	Gorontalo	297	267	235	799
24	Sulawesi Tengah	744	692	653	2.089
25	Sulawesi Selatan	2.409	2.306	2.224	6.939
26	Sulawesi Barat	280	279	250	809
27	Sulawesi Tenggara	1.054	981	924	2.959
28	M a l u k u	843	822	763	2.428
29	Maluku Utara	452	435	419	1.306
30	B a l i	870	855	854	2.579
31	Nusa Tenggara Barat	1.130	1.049	1.014	3.193
32	Nusa Tenggara Timur	1.990	1.832	1.660	5.482
33	Papua	639	619	571	1.829
34	Papua Barat	330	313	275	918
	Indonesia	48.777	46.907	44.884	140.568

Tabel : 28
Jumlah Rombongan Belajar Sekolah Menengah Kejuruan
Menurut Tingkat Tiap Provinsi
Tahun 2014/15

No.	Provinsi	X	XI	XII	Jumlah
(1)	(2)	(3)	(4)	(5)	(6)
1	DKI Jakarta	2.262	2.233	2.189	6.684
2	Jawa Barat	9.717	9.098	8.383	27.198
3	Banten	2.339	2.222	2.096	6.657
4	Jawa Tengah	7.725	7.256	6.907	21.888
5	DI Yogyakarta	1.048	1.035	1.004	3.087
6	Jawa Timur	7.340	7.123	6.703	21.166
7	Aceh	693	647	603	1.943
8	Sumatera Utara	3.279	3.097	2.992	9.368
9	Sumatera Barat	979	927	893	2.799
10	R i a u	1.048	985	942	2.975
11	Kep. Riau	342	319	312	973
12	J a m b i	568	531	496	1.595
13	Sumatera Selatan	1.095	982	905	2.982
14	Bangka Belitung	246	230	222	698
15	Bengkulu	354	325	322	1.001
16	Lampung	1.390	1.291	1.212	3.893
17	Kalimantan Barat	599	576	510	1.685
18	Kalimantan Tengah	409	354	323	1.086
19	Kalimantan Selatan	557	540	511	1.608
20	Kalimantan Timur	864	836	800	2.500
21	Kalimantan Utara	96	90	84	270
22	Sulawesi Utara	704	678	639	2.021
23	Gorontalo	264	232	218	714
24	Sulawesi Tengah	549	559	489	1.597
25	Sulawesi Selatan	1.677	1.611	1.573	4.861
26	Sulawesi Barat	335	325	277	937
27	Sulawesi Tenggara	465	437	387	1.289
28	M a l u k u	306	293	267	866
29	Maluku Utara	263	254	220	737
30	B a l i	889	894	839	2.622
31	Nusa Tenggara Barat	813	756	718	2.287
32	Nusa Tenggara Timur	873	789	692	2.354
33	Papua	410	392	352	1.154
34	Papua Barat	158	156	152	466
	Indonesia	50.656	48.073	45.232	143.961

Tabel : 29
Jumlah Ruang Kelas Menurut Kondisi dan Jenjang Pendidikan
Semua Jenjang Pendidikan
Tahun 2014/15

No.	Jenjang Pendidikan	Baik	%	Rusak Ringan	%	Rusak Sedang	%	Rusak Berat	%	Rusak Total	%	Jumlah
(1)		(3)	(4)	(5)	(6)	(5)	(6)	(5)	(6)	(7)	(8)	(9)
1	SD	228.750	21,93	579.231	55,53	74.021	7,10	55.229	5,29	105.822	10,15	1.043.053
2.	SMP	79.750	24,25	182.307	55,45	17.926	5,45	12.434	3,78	36.389	11,07	328.806
3.	SM	120.864	44,93	112.181	41,71	6.631	2,47	5.131	1,91	24.173	8,99	268.980
	a. SMA	66.279	46,97	56.654	40,15	3.767	2,67	2.876	2,04	11.544	8,18	141.120
	b. SMK	54.585	42,69	55.527	43,43	2.864	2,24	2.255	1,76	12.629	9,88	127.860

Grafik : 10
Persentase Ruang Kelas Menurut Kondisi
Semua Jenjang Pendidikan
Tahun 2014/15

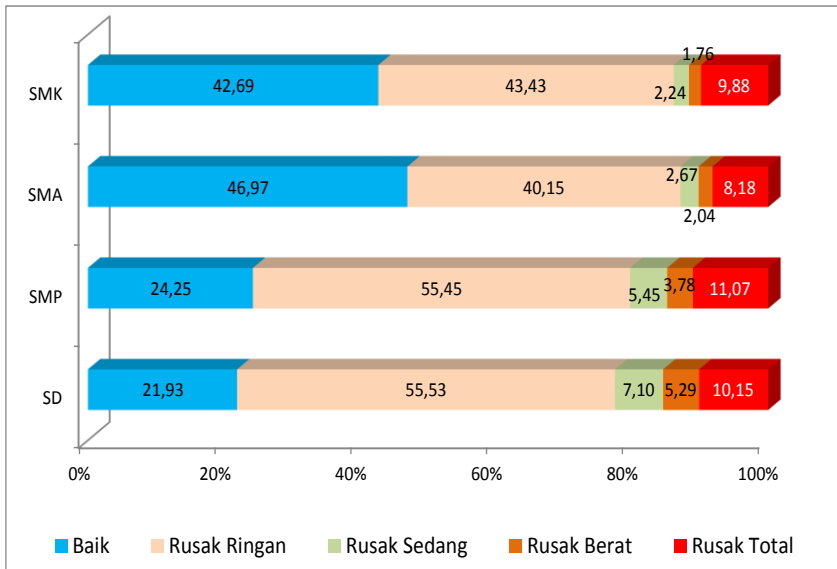

Tabel : 30
Jumlah Ruang Kelas Sekolah Dasar
Menurut Kondisi Tiap Provinsi
Tahun 2014/15

No.	Provinsi	Baik	Rusak Ringan	Rusak Sedang	Rusak Berat	Rusak Total	Jumlah
(1)	(2)	(3)	(4)	(5)	(6)	(7)	(8)
1	DKI Jakarta	10.302	8.156	774	500	5.328	25.060
2	Jawa Barat	22.364	80.023	11.671	8.627	14.148	136.833
3	Banten	8.572	17.882	2.358	1.630	4.371	34.813
4	Jawa Tengah	25.021	75.971	9.112	6.618	10.508	127.230
5	DI Yogyakarta	3.351	8.898	566	321	719	13.855
6	Jawa Timur	27.091	77.867	9.532	7.057	12.548	134.095
7	Aceh	5.644	13.582	1.598	1.306	1.788	23.918
8	Sumatera Utara	19.467	36.799	4.069	3.097	6.519	69.951
9	Sumatera Barat	7.925	16.602	1.611	992	2.708	29.838
10	Riau	7.170	16.167	1.927	1.430	3.288	29.982
11	Kep. Riau	2.059	3.801	325	190	782	7.157
12	Jambi	3.357	9.887	1.590	1.131	1.659	17.624
13	Sumatera Selatan	8.433	18.899	2.322	1.411	3.347	34.412
14	Bangka Belitung	2.472	3.121	209	87	561	6.450
15	Bengkulu	1.901	6.236	725	526	848	10.236
16	Lampung	5.661	19.096	2.740	2.262	3.984	33.743
17	Kalimantan Barat	5.121	16.177	2.521	1.877	2.723	28.419
18	Kalimantan Tengah	3.635	9.851	1.128	723	1.393	16.730
19	Kalimantan Selatan	5.106	12.028	1.019	741	1.489	20.383
20	Kalimantan Timur	4.324	7.577	809	590	1.950	15.250
21	Kalimantan Utara	709	1.585	300	192	797	3.583
22	Sulawesi Utara	4.325	7.059	862	705	1.737	14.688
23	Gorontalo	2.284	3.389	200	180	300	6.353
24	Sulawesi Tengah	4.807	9.214	1.567	1.252	2.005	18.845
25	Sulawesi Selatan	10.057	24.825	3.024	2.217	3.721	43.844
26	Sulawesi Barat	1.438	4.773	809	581	933	8.534
27	Sulawesi Tenggara	3.517	8.351	1.115	1.077	1.457	15.517
28	Maluku	3.117	5.988	758	496	1.020	11.379
29	Maluku Utara	1.246	4.242	690	798	896	7.872
30	Bali	5.086	9.060	653	304	1.292	16.395
31	Nusa Tenggara Barat	4.224	11.554	1.723	1.231	2.116	20.848
32	Nusa Tenggara Timur	5.362	20.193	3.861	3.353	5.534	38.303
33	Papua	2.656	7.256	1.329	1.238	2.389	14.868
34	Papua Barat	946	3.122	524	489	964	6.045
	Indonesia	228.750	579.231	74.021	55.229	105.822	1.043.053

Tabel : 31
Jumlah Ruang Kelas Sekolah Menengah Pertama
Menurut Kondisi Tiap Provinsi
Tahun 2014/15

No.	Provinsi	Baik	Rusak Ringan	Rusak Sedang	Rusak Berat	Rusak Total	Jumlah
(1)	(2)	(3)	(4)	(5)	(6)	(7)	(8)
1	DKI Jakarta	5.108	3.546	300	189	1.353	10.496
2	Jawa Barat	10.628	27.508	3.025	2.000	5.987	49.148
3	Banten	3.128	6.161	695	516	1.911	12.411
4	Jawa Tengah	9.121	22.739	2.064	1.200	3.964	39.088
5	DI Yogyakarta	1.424	2.820	90	101	230	4.665
6	Jawa Timur	9.764	24.460	2.134	1.370	3.926	41.654
7	Aceh	1.903	5.229	526	362	702	8.722
8	Sumatera Utara	5.585	11.468	929	742	2.300	21.024
9	Sumatera Barat	2.014	4.524	357	357	810	8.062
10	Riau	2.046	4.759	538	340	1.056	8.739
11	Kep. Riau	776	1.164	97	68	345	2.450
12	Jambi	922	2.870	410	252	432	4.886
13	Sumatera Selatan	2.256	6.120	562	553	1.124	10.615
14	Bangka Belitung	739	948	52	31	143	1.913
15	Bengkulu	677	1.943	245	141	387	3.393
16	Lampung	2.270	6.098	751	442	1.205	10.766
17	Kalimantan Barat	1.644	4.508	471	318	905	7.846
18	Kalimantan Tengah	1.027	2.713	171	76	340	4.327
19	Kalimantan Selatan	1.204	2.636	188	113	400	4.541
20	Kalimantan Timur	1.319	2.639	196	90	677	4.921
21	Kalimantan Utara	294	408	69	31	164	966
22	Sulawesi Utara	1.134	2.695	260	151	494	4.734
23	Gorontalo	720	1.087	36	33	173	2.049
24	Sulawesi Tengah	1.290	2.800	343	352	685	5.470
25	Sulawesi Selatan	3.528	7.902	720	482	1.428	14.060
26	Sulawesi Barat	434	1.378	183	84	268	2.347
27	Sulawesi Tenggara	1.206	3.051	293	213	538	5.301
28	Maluku	802	2.102	247	181	507	3.839
29	Maluku Utara	374	1.229	177	193	289	2.262
30	Bali	1.925	2.182	157	54	650	4.968
31	Nusa Tenggara Barat	1.537	3.625	360	294	680	6.496
32	Nusa Tenggara Timur	1.933	5.892	925	811	1.627	11.188
33	Papua	779	2.165	205	196	443	3.788
34	Papua Barat	239	938	150	98	246	1.671
	Indonesia	79.750	182.307	17.926	12.434	36.389	328.806

Tabel : 32
Jumlah Ruang Kelas Sekolah Menengah Atas
Menurut Kondisi Tiap Provinsi
Tahun 2014/15

No.	Provinsi	Baik	Rusak Ringan	Rusak Sedang	Rusak Berat	Rusak Total	Jumlah
(1)	(2)	(3)	(4)	(5)	(6)	(7)	(8)
1	DKI Jakarta	3.163	1.676	25	9	360	5.233
2	Jawa Barat	8.208	6.411	507	285	1.534	16.945
3	Banten	2.477	1.837	191	88	483	5.076
4	Jawa Tengah	7.311	4.245	251	134	759	12.700
5	DI Yogyakarta	1.092	765	30	5	109	2.001
6	Jawa Timur	7.760	6.312	305	323	1.214	15.914
7	Aceh	2.136	2.465	202	121	354	5.278
8	Sumatera Utara	4.611	4.155	296	191	852	10.105
9	Sumatera Barat	2.520	1.658	72	106	319	4.675
10	Riau	2.162	1.882	127	97	304	4.572
11	Kep. Riau	594	429	26	18	140	1.207
12	Jambi	846	1.133	97	48	215	2.339
13	Sumatera Selatan	3.019	2.257	173	136	427	6.012
14	Bangka Belitung	447	245	6	11	69	778
15	Bengkulu	505	858	19	58	160	1.600
16	Lampung	1.787	2.228	145	129	382	4.671
17	Kalimantan Barat	1.498	1.347	83	139	294	3.361
18	Kalimantan Tengah	834	815	56	42	187	1.934
19	Kalimantan Selatan	1.087	800	17	7	151	2.062
20	Kalimantan Timur	1.077	843	18	13	146	2.097
21	Kalimantan Utara	208	148	8	3	71	438
22	Sulawesi Utara	907	881	81	34	127	2.030
23	Gorontalo	367	400	1	13	82	863
24	Sulawesi Tengah	891	786	75	57	213	2.022
25	Sulawesi Selatan	3.144	2.910	236	131	535	6.956
26	Sulawesi Barat	431	272	24	9	78	814
27	Sulawesi Tenggara	1.336	1.145	75	69	191	2.816
28	Maluku	676	1.132	130	90	200	2.228
29	Maluku Utara	393	613	54	70	108	1.238
30	Bali	1.317	835	16	18	204	2.390
31	Nusa Tenggara Barat	1.220	1.528	96	91	270	3.205
32	Nusa Tenggara Timur	1.436	2.222	253	251	757	4.919
33	Papua	544	961	51	54	165	1.775
34	Papua Barat	275	460	21	26	84	866
	Indonesia	66.279	56.654	3.767	2.876	11.544	141.120

Tabel : 33
Jumlah Ruang Kelas Sekolah Menengah Kejuruan
Menurut Kondisi Tiap Provinsi
Tahun 2014/15

No.	Provinsi	Baik	Rusak Ringan	Rusak Sedang	Rusak Berat	Rusak Total	Jumlah
(1)	(2)	(3)	(4)	(5)	(6)	(7)	(8)
1	DKI Jakarta	2.511	2.423	83	130	547	5.694
2	Jawa Barat	9.672	9.823	603	536	2.917	23.551
3	Banten	2.151	2.726	184	107	703	5.871
4	Jawa Tengah	8.289	8.684	267	269	1.780	19.289
5	DI Yogyakarta	1.631	981	14	17	162	2.805
6	Jawa Timur	6.778	8.130	369	325	1.701	17.303
7	Aceh	712	1.006	30	29	159	1.936
8	Sumatera Utara	4.011	3.745	279	187	670	8.892
9	Sumatera Barat	1.298	857	43	18	203	2.419
10	Riau	1.351	1.125	127	68	260	2.931
11	Kep. Riau	354	442	4	5	59	864
12	Jambi	624	726	56	21	132	1.559
13	Sumatera Selatan	1.196	1.114	51	68	264	2.693
14	Bangka Belitung	417	307	11	6	33	774
15	Bengkulu	402	497	26	7	103	1.035
16	Lampung	1.301	1.837	75	62	346	3.621
17	Kalimantan Barat	797	641	52	19	177	1.686
18	Kalimantan Tengah	430	557	16	20	123	1.146
19	Kalimantan Selatan	637	647	43	9	105	1.441
20	Kalimantan Timur	1.104	855	17	28	212	2.216
21	Kalimantan Utara	82	129	24	1	20	256
22	Sulawesi Utara	808	789	32	24	165	1.818
23	Gorontalo	414	333	1	3	31	782
24	Sulawesi Tengah	616	726	25	27	140	1.534
25	Sulawesi Selatan	2.187	1.686	89	17	518	4.497
26	Sulawesi Barat	390	384	15	45	81	915
27	Sulawesi Tenggara	500	596	37	35	114	1.282
28	Maluku	310	313	29	33	76	761
29	Maluku Utara	250	338	9	23	49	669
30	Bali	977	859	1	2	167	2.006
31	Nusa Tenggara Barat	945	762	91	20	183	2.001
32	Nusa Tenggara Timur	834	794	96	69	314	2.107
33	Papua	434	464	62	21	73	1.054
34	Papua Barat	172	231	3	4	42	452
Indonesia		54.585	55.527	2.864	2.255	12.629	127.860

Tabel : 34
Angka Melanjutkan SD ke SMP Tiap Provinsi
Tahun 2014/15

No.	Provinsi	LULUSAN	SISWA BARU SMP	AM %
(1)	(2)	(3)	(4)	(5)
1	DKI Jakarta	134.142	125.956	93,90
2	Jawa Barat	767.720	600.547	78,22
3	Banten	209.614	144.214	68,80
4	Jawa Tengah	528.158	408.246	77,30
5	DI Yogyakarta	49.078	43.385	88,40
6	Jawa Timur	525.074	424.290	80,81
7	Aceh	86.595	66.380	76,66
8	Sumatera Utara	295.637	220.994	74,75
9	Sumatera Barat	109.491	72.778	66,47
10	R i a u	122.518	84.438	68,92
11	Kep. Riau	26.767	26.607	99,40
12	J a m b i	67.381	41.101	61,00
13	Sumatera Selatan	150.817	117.783	78,10
14	Bangka Belitung	23.022	18.999	82,53
15	Bengkulu	37.990	28.961	76,23
16	Lampung	161.544	106.643	66,01
17	Kalimantan Barat	99.370	77.504	78,00
18	Kalimantan Tengah	52.331	35.657	68,14
19	Kalimantan Selatan	64.306	40.246	62,59
20	Kalimantan Timur	57.452	51.590	89,80
21	Kalimantan Utara	10.979	10.318	93,98
22	Sulawesi Utara	43.726	40.085	91,67
23	Gorontalo	24.537	16.449	67,04
24	Sulawesi Tengah	56.136	42.365	75,47
25	Sulawesi Selatan	165.682	130.920	79,02
26	Sulawesi Barat	28.433	20.439	71,88
27	Sulawesi Tenggara	55.337	41.245	74,53
28	M a l u k u	44.056	31.592	71,71
29	Maluku Utara	21.460	19.689	91,75
30	B a l i	65.869	65.308	99,15
31	Nusa Tenggara Barat	89.685	60.190	67,11
32	Nusa Tenggara Timur	126.469	107.931	85,34
33	Papua	49.347	38.401	77,82
34	Papua Barat	18.776	14.782	78,73
Indonesia		4.369.499	3.376.033	77,26

Tabel : 35
Angka Melanjutkan SMP ke SM Tiap Provinsi
Tahun 2014/15

No.	Provinsi	LULUSAN	SISWA BARU SM	AM %
(1)	(2)	(3)	(4)	(5)
1	DKI Jakarta	127.428	115.487	90,63
2	Jawa Barat	528.310	487.894	92,35
3	Banten	133.607	125.896	94,23
4	Jawa Tengah	390.887	359.609	92,00
5	DI Yogyakarta	45.818	43.403	94,73
6	Jawa Timur	389.556	383.306	98,40
7	Aceh	68.145	59.688	87,59
8	Sumatera Utara	212.574	210.653	99,10
9	Sumatera Barat	71.764	70.558	98,32
10	R i a u	76.424	71.409	93,44
11	Kep. Riau	22.474	19.463	86,60
12	J a m b i	38.586	37.924	98,28
13	Sumatera Selatan	102.023	97.503	95,57
14	Bangka Belitung	17.143	14.817	86,43
15	Bengkulu	25.740	22.770	88,46
16	Lampung	94.676	85.034	89,82
17	Kalimantan Barat	59.729	52.004	87,07
18	Kalimantan Tengah	26.313	26.002	98,82
19	Kalimantan Selatan	36.031	35.296	97,96
20	Kalimantan Timur	44.629	43.468	97,40
21	Kalimantan Utara	7.829	7.294	93,17
22	Sulawesi Utara	35.000	32.829	93,80
23	Gorontalo	14.544	14.276	98,16
24	Sulawesi Tengah	35.524	32.592	91,75
25	Sulawesi Selatan	128.434	113.122	88,08
26	Sulawesi Barat	17.636	17.202	97,54
27	Sulawesi Tenggara	38.403	37.038	96,45
28	M a l u k u	28.197	27.172	96,36
29	Maluku Utara	17.753	16.047	90,39
30	B a l i	60.090	54.182	90,17
31	Nusa Tenggara Barat	56.759	55.765	98,25
32	Nusa Tenggara Timur	84.218	73.243	86,97
33	Papua	26.294	25.122	95,54
34	Papua Barat	13.051	11.202	85,83
Indonesia		3.075.589	2.879.270	93,62

Tabel : 36
Angka Partisipasi Kasar
PAUD, SD, SMP, SM Sederajat
Tahun 2014/15

No.	Jenjang Pendidikan	Kelompok Usia	Penduduk Usia Sek.	Jumlah Siswa	APK (%)
(1)	(2)	(3)	(4)	(5)	(6)
1.	PAUD	3–6 tahun	18.951.100	12.905.699	68,10
2.	TK dan Sederajat	4–6 tahun	14.110.000	5.538.468	39,25
3.	SD dan sederajat	7–12 tahun	27.234.500	29.699.771	109,05
4.	SMP dan sederajat	13–15 tahun	13.332.200	13.400.196	100,51
5.	SM dan sederajat	16–18 tahun	13.251.300	10.009.309	75,53

Grafik : 11
Angka Partisipasi Kasar
PAUD, SD, SMP, SM Sederajat
Tahun 2014/15

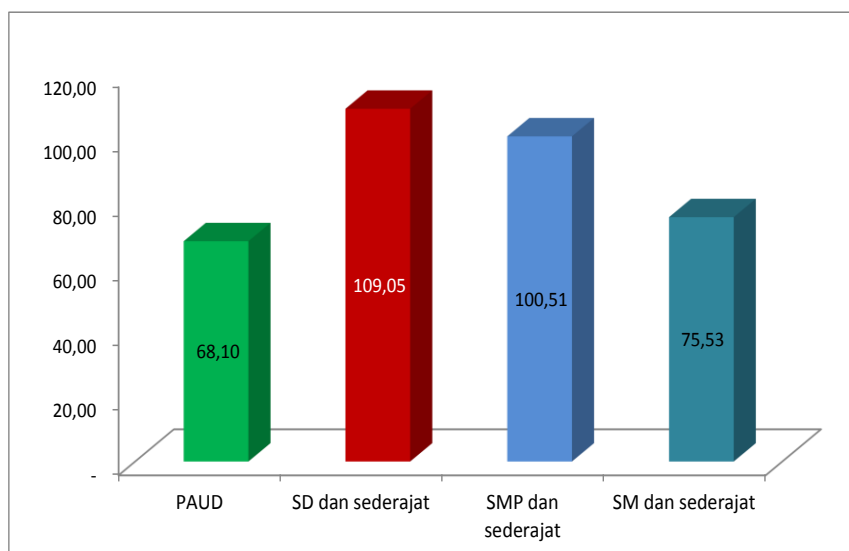

Tabel : 37
Angka Partisipasi Murni
PAUD, SD, SMP, SM Sederajat
Tahun 2014/15

No.	Jenjang Pendidikan	Kelompok Usia	Penduduk Usia Sek.	Jumlah Siswa	APM (%)
(1)	(2)	(3)	(4)	(5)	(6)
1.	TK dan Sederajat	4–6 tahun	14.110.000	4.984.621	35,33
2.	SD dan sederajat	7–12 tahun	27.234.500	25.471.493	93,53
3.	SMP dan sederajat	13–15 tahun	13.332.200	10.767.209	80,76
4.	SM dan sederajat	16–18 tahun	13.251.300	7.573.025	57,15

Grafik : 12
Angka Partisipasi Murni
PAUD, SD, SMP, SM Sederajat
Tahun 2014/15

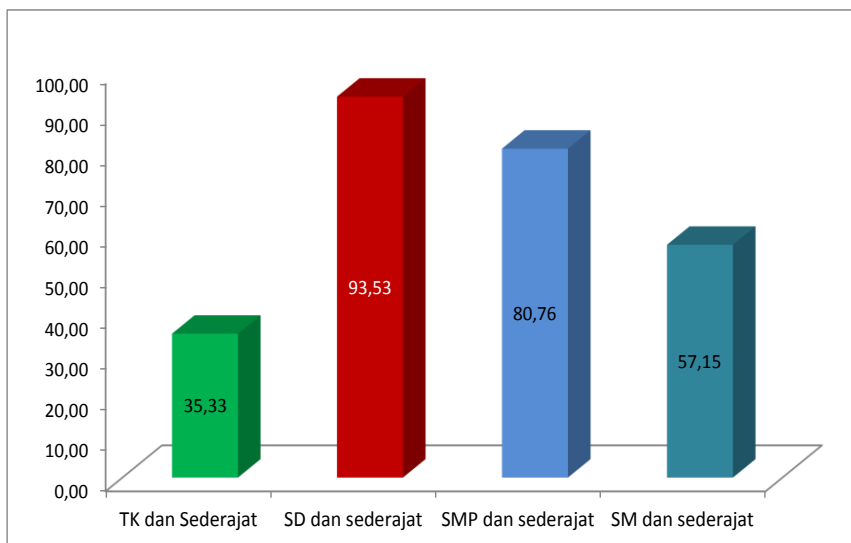

Tabel : 38
Angka Partisipasi Kasar dan Angka Partisipasi Murni Tiap Provinsi
SD, SMP, SM Sederajat
Tahun 2014/15

No.	Provinsi	SD SEDERAJAT		SMP SEDERAJAT		SM SEDERAJAT	
		APK	APM	APK	APM	APK	APM
(1)	(2)	(3)	(4)	(5)	(6)	(7)	(8)
1	DKI Jakarta	104,82	95,54	109,01	93,52	86,54	64,32
2	Jawa Barat	109,83	95,04	98,91	82,13	62,11	45,89
3	Banten	109,25	95,96	99,35	79,87	67,97	50,45
4	Jawa Tengah	105,90	94,39	99,16	81,72	79,32	59,98
5	DI Yogyakarta	98,70	95,33	103,44	87,77	91,40	68,65
6	Jawa Timur	106,05	94,87	102,81	84,22	78,71	57,57
7	Aceh	104,35	92,31	107,64	85,35	88,49	66,52
8	Sumatera Utara	113,30	94,11	103,64	83,31	86,76	67,92
9	Sumatera Barat	112,36	95,92	101,58	79,57	83,94	65,41
10	Riau	113,12	93,64	95,22	76,44	71,69	54,59
11	Kep. Riau	98,35	86,39	103,54	80,93	89,68	65,19
12	Jambi	111,67	95,43	99,19	77,90	72,29	57,39
13	Sumatera Selatan	113,03	91,90	98,48	75,56	73,87	56,11
14	Bangka Belitung	114,38	96,07	93,39	70,23	65,90	47,87
15	Bengkulu	113,94	95,97	103,53	79,41	83,46	62,51
16	Lampung	107,89	93,38	100,61	81,49	68,69	53,10
17	Kalimantan Barat	117,97	93,18	96,85	71,40	81,65	64,88
18	Kalimantan Tengah	117,48	95,62	98,33	74,83	67,63	51,58
19	Kalimantan Selatan	105,38	95,21	97,68	75,98	66,01	52,25
20	Kalimantan Timur	114,69	95,49	100,49	80,94	79,47	61,42
21	Kalimantan Utara	106,65	93,85	90,13	68,51	80,90	65,48
22	Sulawesi Utara	113,03	92,03	104,71	79,73	92,68	72,59
23	Gorontalo	118,03	94,23	96,71	72,13	71,45	57,80
24	Sulawesi Tengah	118,61	92,61	104,22	81,80	68,70	53,26
25	Sulawesi Selatan	110,79	94,22	100,55	79,95	79,41	64,10
26	Sulawesi Barat	115,42	89,24	102,67	75,97	81,35	61,57
27	Sulawesi Tenggara	113,85	90,25	111,80	80,27	88,31	64,65
28	Maluku	106,97	82,03	107,12	78,75	87,18	68,31
29	Maluku Utara	119,14	93,83	115,08	81,85	113,64	74,05
30	Bali	104,53	96,33	109,24	94,19	92,83	71,62
31	Nusa Tenggara Barat	109,78	93,24	107,18	83,73	91,52	70,03
32	Nusa Tenggara Timur	115,79	92,29	96,43	67,37	74,00	61,31
33	Papua	86,69	56,72	61,61	41,30	50,95	35,60
34	Papua Barat	112,57	82,86	96,89	65,58	79,87	58,58
Indonesia		109,05	93,53	100,51	80,76	75,53	57,15

DATA KEBUDAYAAN 2014

Tabel : 1
Data Pokok Kebudayaan
Tahun 2014

No.	Provinsi	Cagar Budaya	Peninggalan Purbakala	Museum	Karya Budaya	Tarian	Jumlah
(1)	(2)	(3)	(4)	(5)	(6)	(7)	(8)
1	DKI Jakarta	88	614	55	61	7	825
2	Jawa Barat	100	1.234	25	236	39	1.634
3	Banten	25	322	1	36	1	385
4	Jawa Tengah	76	1.246	40	329	184	1.875
5	DI Yogyakarta	56	1.674	27	215	19	1.991
6	Jawa Timur	46	935	39	355	27	1.402
7	Aceh	32	377	4	150	38	601
8	Sumatera Utara	30	428	12	148	20	638
9	Sumatera Barat	104	681	8	147	45	985
10	Riau	15	121	3	40	58	237
11	Kepulauan Riau	15	103	1	39	-	158
12	Jambi	20	288	2	101	42	453
13	Sumatera Selatan	16	195	6	82	102	401
14	Bangka Belitung	15	203	1	101	4	324
15	Bengkulu	7	56	1	101	38	203
16	Lampung	7	109	2	40	33	191
17	Kalimantan Barat	12	141	4	235	12	404
18	Kalimantan Tengah	3	528	2	123	60	716
19	Kalimantan Selatan	12	102	2	105	42	263
20	Kalimantan Timur	7	257	4	129	18	415
21	Kalimantan Utara	-	-	-	-	-	-
22	Sulawesi Utara	15	90	2	158	72	337
23	Gorontalo	9	55	-	181	2	247
24	Sulawesi Tengah	5	113	2	116	41	277
25	Sulawesi Selatan	65	786	16	142	88	1.097
26	Sulawesi Barat	1	50	1	21	1	74
27	Sulawesi Tenggara	9	144	2	76	43	274
28	Maluku	110	344	2	50	16	522
29	Maluku Utara	77	202	3	1	1	284
30	Bali	8	491	23	20	24	566
31	Nusa Tenggara Barat	10	375	4	80	57	526
32	Nusa Tenggara Timur	1	250	8	62	98	419
33	Papua	7	30	4	92	12	145
34	Papua Barat	975	25	-	221	-	1.221
	Indonesia	1.978	12.569	306	3.993	1.244	20.090

Grafik : 1
Data Pokok Kebudayaan
Tahun 2014

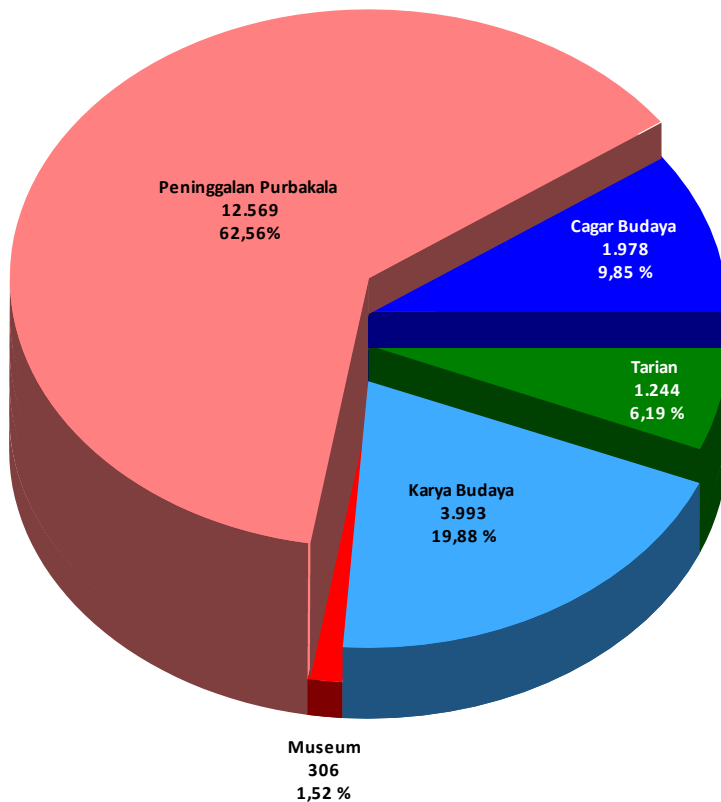

Tabel : 2
Jumlah Museum Menurut Penyelenggara
Tahun 2014

No.	Provinsi	Pusat	Kementerian	Pemda	TNI/Polri	BUMN	Swasta	Jumlah
(1)	(2)	(3)	(4)	(5)	(6)	(7)	(8)	(9)
1	DKI Jakarta	4	8	10	8	6	19	55
2	Jawa Barat	-	6	5	5	1	8	25
3	Banten	-	-	-	-	-	1	1
4	Jawa Tengah	-	4	14	5	3	14	40
5	DI Yogyakarta	1	1	5	4	1	15	27
6	Jawa Timur	-	2	31	4	-	2	39
7	Aceh	-	-	3	-	-	1	4
8	Sumatera Utara	-	-	3	1	-	8	12
9	Sumatera Barat	-	-	5	1	-	2	8
10	Riau	-	-	4	-	-	-	4
11	Kepulauan Riau	-	-	-	-	-	-	-
12	Jambi	-	-	2	-	-	-	2
13	Sumatera Selatan	-	-	4	-	-	2	6
14	Bangka Belitung	-	-	1	-	-	-	1
15	Bengkulu	-	-	1	-	-	-	1
16	Lampung	-	-	1	-	-	1	2
17	Kalimantan Barat	-	-	2	1	-	1	4
18	Kalimantan Tengah	-	-	1	-	-	1	2
19	Kalimantan Selatan	-	-	2	-	-	-	2
20	Kalimantan Timur	-	-	4	-	-	-	4
21	Kalimantan Utara	-	-	-	-	-	-	-
22	Sulawesi Utara	-	-	2	-	-	-	2
23	Gorontalo	-	-	-	-	-	-	-
24	Sulawesi Tengah	-	-	1	-	-	1	2
25	Sulawesi Selatan	-	-	10	-	-	6	16
26	Sulawesi Barat	-	-	1	-	-	-	1
27	Sulawesi Tenggara	-	-	2	-	-	-	2
28	Maluku	-	-	2	-	-	-	2
29	Maluku Utara	-	-	2	-	-	1	3
30	Bali	-	2	8	-	-	13	23
31	Nusa Tenggara Barat	-	-	3	-	-	1	4
32	Nusa Tenggara Timur	-	-	1	-	-	7	8
33	Papua	-	-	3	-	-	1	4
34	Papua Barat	-	-	-	-	-	-	-
Indonesia		5	23	133	29	11	105	306

Tabel : 3
Jumlah Karya Budaya yang
Sudah Ditetapkan Menurut
Provinsi Tahun 2014

No.	Provinsi	Jumlah
(1)	(2)	(3)
1	DKI Jakarta	61
2	Jawa Barat	236
3	Banten	36
4	Jawa Tengah	329
5	DI Yogyakarta	215
6	Jawa Timur	355
7	Aceh	150
8	Sumatera Utara	148
9	Sumatera Barat	147
10	Riau	40
11	Kepulauan Riau	39
12	Jambi	101
13	Sumatera Selatan	82
14	Bangka Belitung	101
15	Bengkulu	101
16	Lampung	40
17	Kalimantan Barat	235
18	Kalimantan Tengah	123
19	Kalimantan Selatan	105
20	Kalimantan Timur	129
21	Kalimantan Utara	-
22	Sulawesi Utara	158
23	Gorontalo	181
24	Sulawesi Tengah	116
25	Sulawesi Selatan	142
26	Sulawesi Barat	21
27	Sulawesi Tenggara	76
28	Maluku	51
29	Maluku Utara	20
30	Bali	80
31	Nusa Tenggara Barat	62
32	Nusa Tenggara Timur	92
33	Papua	221
34	Papua Barat	163
Indonesia		4.156

Tabel : 4
Jumlah Karya Budaya yang Sudah
Ditetapkan Menurut Kategori
Tahun 2014

No	Kategori	Jumlah
1	Arsitektur Tradisional	147
2	Bahasa	8
3	Bahasa Daerah	3
4	Kain Tradisional	95
5	Kearifan Lokal	229
6	Kerajinan Tradisional	252
7	Kuliner Tradisional	452
8	Naskah Kuno	19
9	Naskah Tradisional	7
10	Pakaian Adat	49
11	Pakaian Tradisional	30
12	Permainan Tradisional	332
13	Seni Tradisi	886
14	Senjata Tradisional	41
15	Teknologi Tradisional	152
16	Tradisi Lisan	575
17	Upacara/Ritus	879
	Jumlah	4.156

Tabel : 5
Jumlah Cagar Budaya Berdasarkan Pemugaran
Tahun 2014

No.	Provinsi	Cagar Budaya Berdasarkan Pemugaran		
		Pernah	Tidak pernah	Jumlah
(1)	(2)	(3)	(4)	(5)
1	DKI Jakarta	-	88	88
2	Jawa Barat	-	100	100
3	Banten	-	25	25
4	Jawa Tengah	-	76	76
5	DI Yogyakarta	11	45	56
6	Jawa Timur	20	26	46
7	Aceh	6	26	32
8	Sumatera Utara	8	22	30
9	Sumatera Barat	32	72	104
10	Riau	5	10	15
11	Kepulauan Riau	8	7	15
12	Jambi	9	11	20
13	Sumatera Selatan	4	12	16
14	Bangka Belitung	1	14	15
15	Bengkulu	4	3	7
16	Lampung	2	5	7
17	Kalimantan Barat	7	5	12
18	Kalimantan Tengah	3	-	3
19	Kalimantan Selatan	4	8	12
20	Kalimantan Timur	3	2	5
21	Kalimantan Utara	1	1	2
22	Sulawesi Utara	5	10	15
23	Gorontalo	5	4	9
24	Sulawesi Tengah	3	2	5
25	Sulawesi Selatan	15	50	65
26	Sulawesi Barat	1	-	1
27	Sulawesi Tenggara	1	8	9
28	Maluku	5	105	110
29	Maluku Utara	1	76	77
30	Bali	4	4	8
31	Nusa Tenggara Barat	10	-	10
32	Nusa Tenggara Timur	-	1	1
33	Papua	5	2	7
34	Papua Barat	-	-	-
	Indonesia	183	820	

Grafik : 2
Persentase Cagar Budaya Berdasarkan Pemugaran
Tahun 2014

